

**CRAWLER EXCAVATORS  
14 – 28 METRIC TON**

**DOOSAN®**



	<b>Operating Weight</b>	<b>Bucket Capacity</b> Heaped, ISO / SAE	<b>Rated Power</b> Gross
<b>DX140LC-5</b>	32,783 lb. (14,870 kg)	0.55 yd <sup>3</sup> (0.42 m <sup>3</sup> )	115 hp (86 kW)
<b>DX140LCR-5</b>	34,987 lb. (15,870 kg)	0.55 yd <sup>3</sup> (0.42 m <sup>3</sup> )	115 hp (86 kW)
<b>DX180LC-5</b>	43,224 lb. (19,610 kg)	1.0 yd <sup>3</sup> (0.78 m <sup>3</sup> )	131 hp (98 kW)
<b>DX225LC-5</b>	52,086 lb. (23,626 kg)	1.2 yd <sup>3</sup> (0.92 m <sup>3</sup> )	166 hp (124 kW)
<b>DX235LCR-5</b>	56,019 lb. (25,410 kg)	1.2 yd <sup>3</sup> (0.92 m <sup>3</sup> )	189 hp (141 kW)
<b>DX255LC-5</b>	57,752 lb. (26,196 kg)	1.4 yd <sup>3</sup> (1.1 m <sup>3</sup> )	189 hp (141 kW)



# **WHEN YOU CHOOSE DOOSAN**

as your heavy equipment brand, you'll have the backing of a strong, global organization – with benefits that extend far beyond the capabilities of a new machine.

**DOOSAN**





### **STRONG BRAND**

Doosan began in 1896. Its heritage in excavators goes back to 1978. Wheel loader production began in 1992, while the company's first articulated dump truck was designed in 1972. Throughout its years in the heavy equipment industry, Doosan has listened to its North American customers, making many improvements – and developing new machines – as a result of feedback from owners and operators. From 2005 to 2015, Doosan grew from its position as the seventh-largest construction equipment manufacturer in the world to the fifth-largest.

### **STRONG DEALERS**

Doosan serves you in partnership with its dealers – and similarly, your Doosan dealer is intended to be a trusted partner for you. Whether it's Doosan® parts, authorized service and maintenance, or even advice on how to get more value from your machine, Doosan dealers are behind you on every job.

### **STRONG EQUIPMENT**

Doosan products are known for reliably exceeding customers' most demanding expectations. It's why we're one of the fastest-growing heavy equipment brands in North America. Doosan offers crawler excavators, wheel excavators, compact excavators, wheel loaders, articulated dump trucks, log loaders, material handlers and a variety of job-matched attachments – all designed to perform in the most difficult working conditions.

### **STRONG NORTH AMERICAN OPERATIONS**

Doosan has a solid infrastructure to support your equipment from coast to coast. It includes parts distribution in Illinois and Ontario; service training, product management, sales and marketing support in Georgia; sales training and The Real Operation Center (ROC) customer experience facility in Arizona; plus attachment design and development in Minnesota.

### **STRONG WARRANTY**

Customers choose the months and hours of coverage in their transferable warranty. Options include a standard warranty of 12 months or up to 1,500 hours (depending on the machine), or up to the five-year, 7,500-hour Elite Assurance™ coverage for the powertrain only, the powertrain plus hydraulics or the full machine.



Performance is what it's all about; Doosan delivers what you need and then some. For decades, Doosan machines have proven themselves on thousands of jobsites around the world. Our long carriage (LC) design provides superior stability and optimizes working width for superior performance in heavy digging and lifting operations. Powerful hydraulic, arm and bucket forces – with horsepower to spare – help you get the job done quickly and efficiently.

## Arm and Bucket Force

Save time digging, loading trucks and more with best-in-class hydraulics. You can rely on consistent, reliable power delivery to the arm and bucket – and when you need it, a one-touch power boost momentarily amplifies your hydraulic power. With Doosan, you can confidently take on tough digging conditions that slow other machines down.

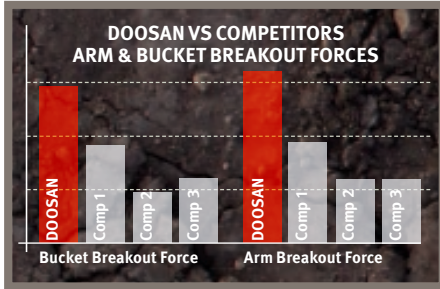

## One-Touch Power Boost

The convenient button on the right-hand joystick provides momentary increased hydraulic power to break through hard ground and other tough digging conditions.

## Swing Torque

The newest Doosan models have an eight to 11 percent increase in swing torque. That means you can easily swing uphill and backfill faster, with better results. Now, every foot of trench eats up less of your schedule.



## Four Power Modes

With four selectable power modes, you have more control over your excavator's performance. Balance fuel consumption and machine power to match your working conditions without even leaving the cab.



**P+** **Power+ mode** delivers the fastest work group speeds to save more time loading trucks. Top digging performance delivers extra power for penetrating hard ground and other tough conditions.

**P** **Power mode** provides excellent power and superior performance for tough digging and heavy lifting. It also provides quick truck loading and fast travel speed to save time.

**S** **Standard power mode** optimizes your fuel consumption and delivers high performance in everyday digging, grading and lifting.

**E** **Economy mode** reduces fuel consumption for low-demand applications and slows down machine movement, which is handy for fine digging, light grading conditions and jobsite conditions that require extra precision.





### **LCR vs. LC**

The near-zero reduced tail swing and the tighter front minimum swing radius on the Doosan LCR models allow you to work close to buildings and in confined areas, such as single lane roadways, without sacrificing performance.

The conventional tail swing overhang on LC models gives you strength and leverage for general construction and traditional excavating applications.

### **Dozer Blade (optional)**

Backfill quickly or gain digging stability with the front dozer blade, available for certain model configurations.

### **Lifting Capacity**

Complete the job faster and lift more with every cycle. Doosan excavators are designed and tested to maximize lifting capability. An optimal swing radius, lift height, and lift position enable you to confidently lift and place objects or dig loads of material in less time.



# PRODUCTIVITY

With quick cycle times, efficient designs and plenty of power, you will fit more work into fewer hours with Doosan excavators.



## Smart Power Control (SPC)

SPC consists of two systems that work together to improve efficiency while maintaining productivity and is controlled by the engine control unit (ECU). Each of the four power modes will function with SPC engaged or disengaged; however, SPC can only be active in the digging work mode.

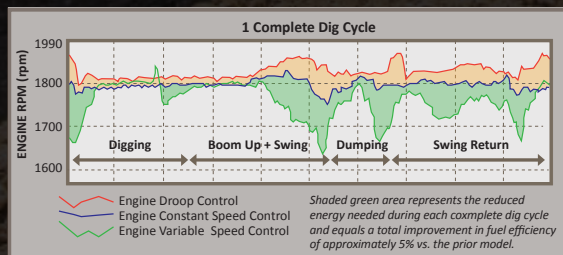

**Variable Speed Control** reduces engine rpm during low workload requirements, like during the swing portion of a dig cycle. This reduces the energy used to perform a task and improves fuel efficiency by up to five percent.

**Pump Torque Control** efficiently matches hydraulic pump torque and engine response to the task, preventing engine overload.

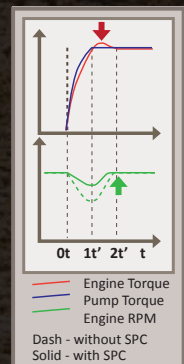





### Auto Idle

To reduce noise, improve jobsite communications and save fuel, the standard auto-idle feature idles your engine automatically when machine functions are not used for four seconds. When you move the controls, the excavator automatically returns to your previous throttle setting.

### Auto Downshift

When turning, pushing and maneuvering, auto downshift reduces the hydraulic flow to the drive system — improving machine responsiveness and controllability. When the load decreases, the excavator automatically shifts back into high range.



### X-Chassis Undercarriage

Get increased ground clearance and maneuverability in softer ground with the X-Chassis undercarriage design. The sloped surfaces also shed debris faster, reducing material buildup and cutting back your cleanup time.



### Fast Cycle Times

Two variable displacement axial piston pumps deliver fast cycle times. Hydraulic flow regeneration delivers the power you need while maximizing efficiency.

### Tier 4 (T4) Compliant

Optimized to provide more power output with reduced fuel consumption, Doosan excavators are designed with T4 compliant engines to reduce air pollution.



### Diesel Oxidation Catalyst (DOC)

In the DOC, carbon monoxide (CO) and particulate matter (PM) emissions are transformed into harmless water (H<sub>2</sub>O) and carbon dioxide (CO<sub>2</sub>).

### Evaporative Module

In the evaporative module, or mixing pipe, diesel exhaust fluid (DEF) solution is injected in small doses mixed with hot exhaust gases, decomposing it into urea (CO(NH<sub>2</sub>)<sub>2</sub>) and water vapor, which then catalyzes into carbon dioxide and ammonia (NH<sub>3</sub>).

### Selective Catalytic Reduction (SCR)

In the SCR canister, nitrogen oxides mixes with ammonia, and a chemical reaction takes place, resulting in nitrogen (N) and water vapor emitting from the system. The SCR canister also acts as the silencer or muffler.

### Diesel Exhaust Fluid (DEF)

DEF is a solution of pure urea and deionized water. A minimum level of DEF is required for proper machine operation, and the DEF supply tank is heated for proper operation in cold weather. DEF is available from your Doosan dealer in various container sizes.



### Cooled Exhaust Gas Recirculation (CEGR)

CEGR recycles a portion of the engine exhausts to reduce oxygen (O) and lower the temperature in the combustion chamber. This reduces nitrogen oxide (NO<sub>x</sub>) emissions.

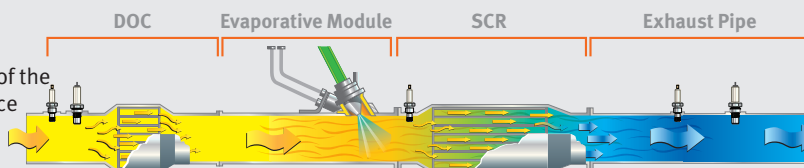



# DURABILITY / RELIABILITY

Like you, Doosan excavators are ready to keep at it until the job is finished. They're protected with solid construction and heavy-duty features that keep you running longer – so you can make more money working and spend less downtime in the shop.



## D-Channel Frame Design

This innovative upper structure frame design adds strength to withstand more side shock, protecting your machine's vital components.

## Air-to-Air Fuel Cooler

The air-to-air fuel cooler reduces fuel temperature to increase your machine's overall efficiency and protect engine components.

## Automatic Belt Tensioner

A spring-applied automatic belt compensates for regular wear and maintains a constant tension on the engine accessory belt.

## Variable Speed Hydraulic Cooling Fan

The hydraulic oil cooler utilizes a variable speed cooling fan. The speed of the fan adjusts as required by the demands of your excavator. In tough, difficult applications, the fan runs more for optimized cooling. When you're in lighter duty conditions, the fan runs less to increase efficiency and reduce noise.







### Heavy Duty Wear Plates

Ultra-hard and wear-resistant, these plates at the end of your arm extend the service intervals for your bucket pin-up point. By minimizing the tolerance between the bucket and arm, they maintain high breakout forces and ensure greater productivity.

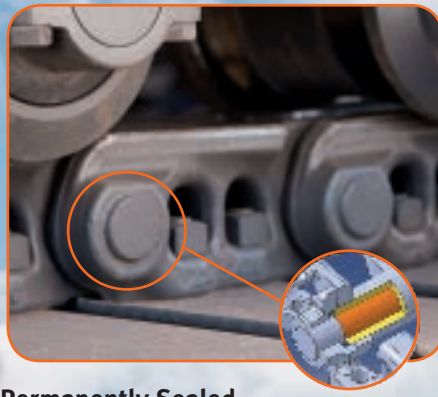

### Permanently Sealed, Lubricated Track Pins

Pin links on Doosan excavator tracks are permanently sealed. They never need greasing. That means you reduce your operating costs and increase your uptime.



### Recessed Drive Motors

Drive motors contained and recessed within the track width are protected from potential damage, resulting in more uptime.



### Cast Ends and Pin Bosses

All the major pin points on the boom and arm are castings for extra strength in tough working conditions. Plus, additional reinforcement around the bosses and internal gussets give a long life for the work group.



## COMFORT

You can't do as much work if you're not comfortable. Operator comfort is essential. Great visibility, a deluxe, adjustable seat and numerous perks and comfort features help operators to push performance to the limit. Easy to enter, exit and work in, Doosan cabins give you remarkable standard features that bring superior comfort to the job.



### Visibility

The Doosan cabin allows you to focus on your work – instead of struggling to see it. The large Doosan cabin provides an excellent viewing area on the front and side windows. When loading trucks or working overhead, the overhead window gives you great visibility above the

machine. Narrow corner pillars, small window joints and a wiper mounted on the pillar – instead of on the glass surface – give an unobstructed view. Sun shades on the front and top windows shield operators from the sun and reduce eye strain.

### Other Cabin Features

- Improved floor space for your feet, increased cab space for your legs, arms, and head
- 180-degree swinging door
- Wide entry/exit area
- Grab handles
- Standard radio and antenna
- Standard CD player and MP3 player input
- 12 V power port
- Adjustable side window openings for fresh air



### Quiet Operation

A complete, sound-isolating cabin seal reduces the noise inside the pressurized cab to an extremely low level. Compartmentalized components reduce noise output outside the cab. Even the cabin frame and seat are designed to absorb vibration and significantly increase operator comfort.

### Adjustable Comfort

The standard air suspension seat has multiple adjustment points, allowing you to select the most comfortable position.

- A Control Stand/Seat Base Fore/Aft
- B Control Stand/Seat Move with Suspension
- C Control Stand/Seat Height
- D Seat Fore/Aft
- E Seat Cushion Fore/Aft
- F Seat Cushion Angle
- G Back Recline
- H Lumbar Support
- I Headrest Fore/Aft and Up/Down
- J Control Stands Up/Down
- K Seat Heater

### Automotive Style Heat and Air Conditioning

High capacity heating and cooling vents and an easy-to-control temperature keep you comfortable all year long. Automatic temperature control senses and adjusts to the temperature setting automatically. A memory function returns it to your preferred temperature if you shut the machine off and restart later.

### Standard Rearview Camera

Provides the operator with an additional means to view the machine's surroundings, allowing for increased productivity.



### Easy-to-Read LCD Display Panel

An easy-to-read LCD display panel is placed within easy view for monitoring critical machine data, receiving errors or warnings, and the rearview camera display. A big, seven-inch display also switches to a night view.





# EASY MAINTENANCE

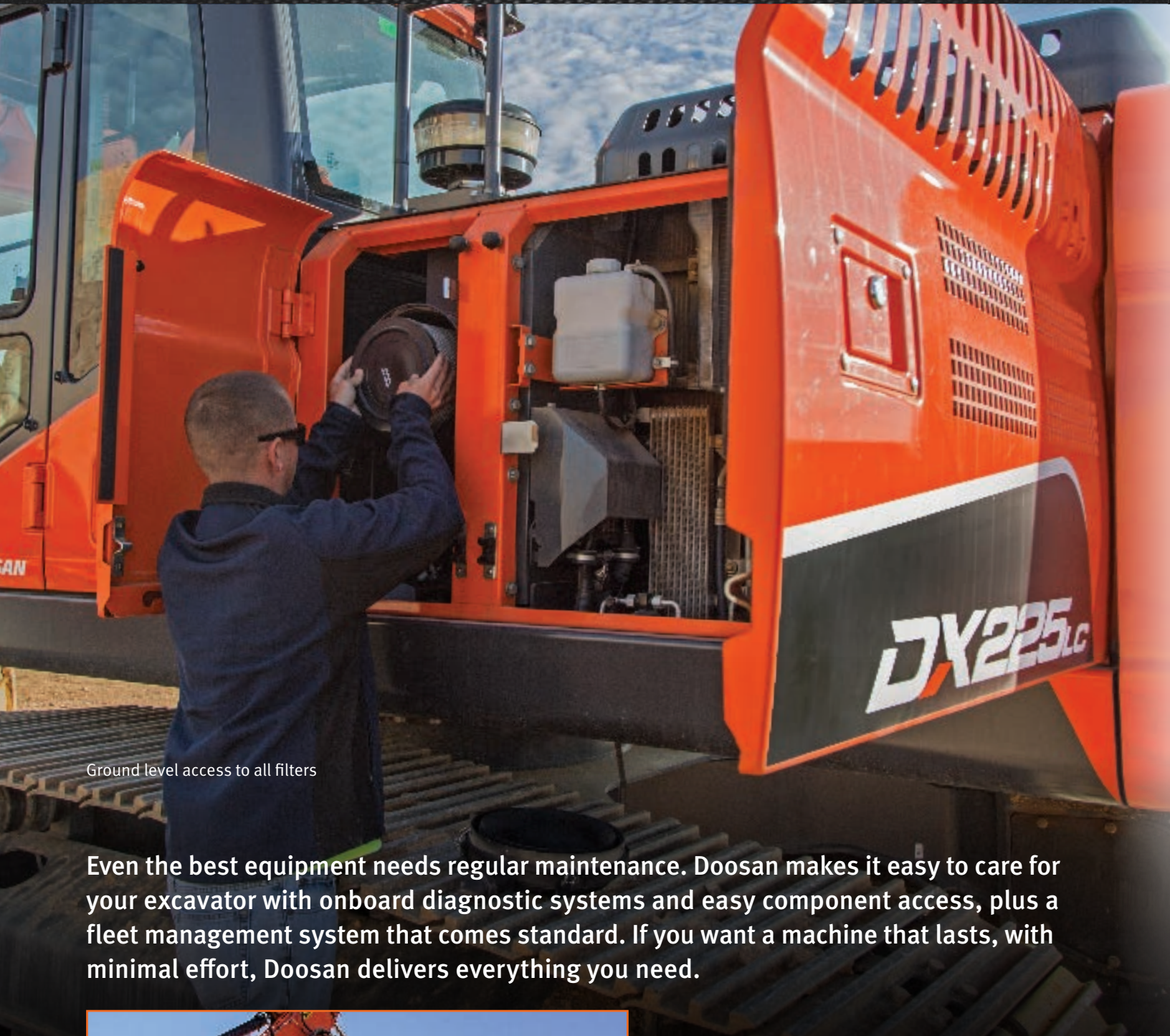

Ground level access to all filters

Even the best equipment needs regular maintenance. Doosan makes it easy to care for your excavator with onboard diagnostic systems and easy component access, plus a fleet management system that comes standard. If you want a machine that lasts, with minimal effort, Doosan delivers everything you need.



Easy access to regular inspection points

## Easy Component Access

Access panels are easy to find and open from the top, bottom and sides of the excavator. A large engine cover provides plenty of room to reach the top side of the engine, while a hinged belly pan allows access from the bottom. Solid steel side panels provide access to regular daily maintenance items which makes for quick, easy service and a lower cost of operation.





# DOOSAN<sup>®</sup>

## CONNECT<sup>®</sup>

Durable monitoring hardware is built into your Doosan machine, and it collects reliable, accurate and robust data with every minute of operation. The data is uploaded automatically to the Doosan Connect online system using dual-mode communications (cellular and satellite) for maximum coverage. Your designated users can monitor the machine status from anywhere using the Doosan Connect website and mobile application.

*Key benefits include:*

- Critical code awareness or proactive service
- Preventative maintenance planning
- Operational efficiency management
- Location visibility



### Oil and Filter Life

Easily review the hours since the last maintenance for filters and oils. Your machine will remind you when each oil and filter needs replacing 10 working hours before service is due, assisting you in regular maintenance scheduling.



### Doosan Monitoring System with Laptop Access

During operation, the Doosan Monitoring System monitors all critical data and provides a complete history of operation and a real-time log of machine failures to your dealer's technician. Armed with information like this, dealer service personnel can fix issues faster — and you can get back to work.

### Auxiliary Mode Switch

If needed, an auxiliary mode switch allows you to finish a job or move your excavator to a convenient location for service.

### Self-Diagnostics

An LCD monitor helps you track critical systems in real time and access historical machine alerts from within the cabin.



### Centralized Boom Grease Points

Daily maintenance is critical — and it's simple with the centralized grease banks on the base of the boom.



Doosan excavators are made to do more because they are optimized for attachment versatility. Virtually any attachment designed for its operating weight can be matched to your excavator, and you can easily increase your utilization.



Breaker

## Selectable Work Modes

Tailor your excavator's performance to the job at hand with four unique work modes. Two modes recalibrate machine power for digging or lifting. Two change the auxiliary hydraulic flow for specific types of attachments. Just change a few settings with the LCD display panel to quickly optimize performance and protect your hydraulic components.

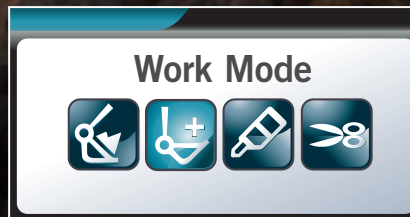

### Digging

Your default setting delivers the performance you need for general excavation, loading and lifting. The four power modes give it a huge range of versatility for many different digging applications.



### Lifting

The increased pump torque, low engine rpms and automatic power boost provide extra muscle when lifting materials – like pipe or concrete barriers.



## Doosan Attachments

Gear up for your job with the hardworking line of Doosan attachments. We build our own tough breakers, clamps, plate compactors and a wide array of bucket types and sizes. All of them are built to Doosan machine specifications for superior reliability and performance.



Clamp



Plate Compactor



Quick Coupler



Bucket



### Hydraulic Attachment Management

Using the LCD screen, the operator can configure 10 different attachment presets: five each for 1-way and 2-way flow. Each preset selection can be matched to specific operational requirements of an attachment by limiting the maximum pressure and the minimum/maximum flow rate that is delivered to the attachment.

When changing hydraulic attachments, the operator can easily select the appropriate preset to optimize machine and attachment functionality. Password protection functionality within the system discourages improper attachment preset selection for operators or rental users with limited understanding of hydraulic systems.

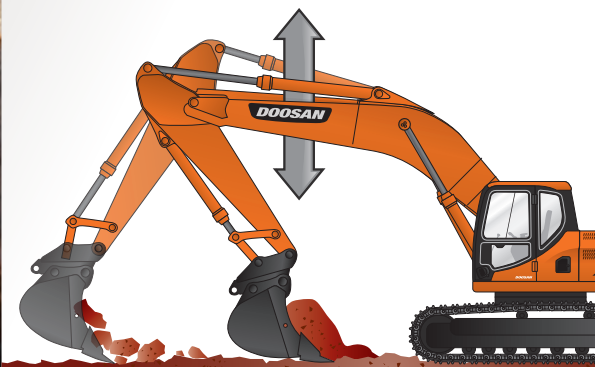

### Intelligent Floating Boom

Ideal for finishing work, operators can focus on the arm and bucket with the intelligent floating boom. This setting allows the boom to move freely with the contours of the ground. When engaged, the boom does not utilize hydraulic flow, increasing efficiency and productivity by saving fuel and improving cycle times.



**Breaker**, or one-way auxiliary hydraulic flow, works great for attachments that only require hydraulic power from one direction, such as breakers or plate compactors. This mode also maintains consistent downward pressure for maximum attachment performance and component protection.



**Shear**, or two-way auxiliary hydraulic flow, is ideal for attachments that need bi-directional hydraulic flow, such as a hydraulic clamp or tilting bucket.

### Roller Switch

Easily control and vary the speed at which a two-way hydraulic attachment functions, such as opening and closing a hydraulic clamp, with the roller switch on the right joystick.





## General

	UNIT	DX140LC-5 Standard Arm (US20)	DX140LCR-5 Standard Arm (US20)	DX180LC-5 Standard Arm (US20)	DX225LC-5 Standard Arm (US20)	DX235LC-5 Standard Arm (US20)	DX255LC-5 Standard Arm (US20)
<b>ENGINE</b>							
MAKE		Perkins	Perkins	Perkins	Doosan	Doosan	Doosan
MODEL		1204F	1204F	1204F	DL06P	DL06P	DL06P
NUMBER OF CYLINDERS		4	4	4	6	6	6
RATED POWER GROSS (HP per SAE J1995)	hp (kW) @ rpm	115 (86) @ 2000	115 (86) @ 2000	131 (98) @ 2000	166 (124) @ 1800	189 (141) @ 1900	189 (141) @ 1900
RATED POWER NET (HP per SAE J1349)	hp (kW) @ rpm	113 (85) @ 2000	113 (85) @ 2000	129 (96) @ 2000	162 (121) @ 1800	181 (135) @ 1900	184 (137) @ 1900
MAXIMUM TORQUE (GROSS) (SAE J1995)	ft.-lb. (Nm) @ rpm	369 (500) @ 1400	369 (500) @ 1400	369 (500) @ 1400	557 (755) @ 1400	593 (804) @ 1400	593 (804) @ 1400
PISTON DISPLACEMENT	in <sup>3</sup> (L)	269 (4.4)	269 (4.4)	269 (4.4)	359 (5.9)	359 (5.9)	359 (5.9)
BORE AND STROKE	in. x in. (mm x mm)	4.1 x 5.0 (105 x 127)	4.1 x 5.0 (105 x 127)	4.1 x 5.0 (105 x 127)	3.9 x 4.9 (100 x 125)	3.9 x 4.9 (100 x 125)	3.9 x 4.9 (100 x 125)
STARTER	V. hp (kW)	24. 6.0 (4.5)	24. 6.0 (4.5)	24. 6.0 (4.5)	24V. 8.6 (6.0)	24V. 8.6 (6.0)	24V. 8.6 (6.0)
BATTERY (Qty 2)	V. AH	12V. 100AH	12V. 100AH	12V. 100AH	2 x 12V. 150AH	2 x 12V. 150AH	2 x 12V. 150AH
ALTERNATOR	V. amp	24V. 85A	24V. 85A	24V. 85A	24V. 60A	24V. 60A	24V. 60A
AIR CLEANER		Double Elements	Double Elements	Double Elements	Double Elements	Double Elements	Double Elements
<b>HYDRAULICS</b>							
MAIN PUMPS	gpm (L/min)	2 x 30.1 (2 x 114)	2 x 30.1 (2 x 114)	2 x 40.2 (2 x 152)	2 x 54.6 (2 x 207)	1 x 58.7 (1 x 223)	2 x 57.9 (2 x 219)
PILOT PUMP (Gear Design)	gpm (L/min)	7.9 (30)	7.9 (30)	7.9 (30)	7.1 (27)	6.9 (26)	7.5 (28.5)
RELIEF PRESSURE (Normal)	psi (kg/cm <sup>2</sup> )	4694 (330)	4694 (330)	4694 (330)	4694 (330)	4978 (350)	4978 (350)
RELIEF PRESSURE (Boost)	psi (kg/cm <sup>2</sup> )	4978 (350)	4978 (350)	4978 (350)	4978 (350)	5263 (370)	5263 (370)
<b>MAXIMUM SYSTEM PRESSURE</b>							
BOOM/ARM/BUCKET (Normal Mode)	psi (kg/cm <sup>2</sup> )	4694 (330)	4694 (330)	4694 (330)	4694 (330)	4978 (350)	4978 (350)
BOOM/ARM/BUCKET (Power Mode)	psi (kg/cm <sup>2</sup> )	4978 (350)	4978 (350)	4978 (350)	4978 (350)	5263 (370)	5263 (370)
TRAVEL (Normal Mode)	psi (kg/cm <sup>2</sup> )	4694 (330)	4694 (330)	4694 (330)	4694 (330)	4978 (350)	4978 (350)
TRAVEL (Power Mode)	psi (kg/cm <sup>2</sup> )	4978 (350)	4978 (350)	4978 (350)	4978 (350)	5263 (370)	5263 (370)
SWING (Normal Mode)	psi (kg/cm <sup>2</sup> )	4694 (330)	4694 (330)	4694 (330)	4694 (330)	4978 (350)	4978 (350)
SWING (Power Mode)	psi (kg/cm <sup>2</sup> )	4978 (350)	4978 (350)	4978 (350)	4978 (350)	5263 (370)	5263 (370)
<b>UNDERCARRIAGE</b>							
UPPER ROLLERS (Each Track)		1	1	2	2	2	2
LOWER ROLLERS (Each Track)		7	7	7	8	9	10
NUMBER OF SHOES (Links Per Side)		46	46	45	49	49	51
<b>SWING MECHANISM</b>							
SWING SPEED	rpm	0 - 10.7	0 - 10.7	0 - 10.5	0 - 10.9	0 - 11.3	0 - 10.0
SWING TORQUE	lb.-ft. (kgf-m)	34.718 (4800)	34.718 (4800)	46.653 (6450)	60.757 (8400)	71.245 (9850)	71.462 (9880)
<b>DRIVE SYSTEM</b>							
TRAVEL SPEED (Low - High)	mph (km/h)	1.8 - 3.1 (3.0 - 4.9)	1.7 - 2.9 (2.8 - 4.7)	1.9 - 3.2 (3.1 - 5.1)	1.9 - 3.4 (3.0 - 5.5)	2.0 - 3.6 (3.2 - 5.8)	1.9 - 3.5 (3.2 - 5.6)
TRACTION FORCE. MAX (Drawbar Pull)	lb.-ft. (kgf-m)	35.935 (4968)	29.101 (4023)	45.195 (6248)	60.715 (8394)	64.375 (8900)	62.832 @ 100 % (8687 @ 100 %)
MAXIMUM GRADE	% (°)	70 (35)	70 (35)	70 (35)	70 (35)	70 (35)	70 (35)
<b>ENVIRONMENT</b>							
SOUND LEVEL (2000/14/EC)	dB(A)	101	101	102	103	103	103
CABIN SOUND LEVEL (ISO 6396)	dB(A)	70	73	68	70	74	70
<b>REFILL CAPACITIES</b>							
FUEL TANK	gal. (L)	70 (265)	55.5 (210)	77.1 (292)	105.7 (400)	81.9 (310)	111 (420)
DEF TANK	gal. (L)	5 (19)	5 (19)	5 (19)	9 (35)	9 (35)	8 (31.5)
COOLING SYSTEM (Radiator Capacity)	gal. (L)	6.6 (25)	6.6 (25)	6.6 (25)	10.1 (38)	8.2 (31)	7.4 (28)
ENGINE OIL	gal. (L)	2.1 (8)	2.1 (8)	2.1 (8)	7.1 (27)	7.1 (27)	7.1 (27)
SWING DRIVE	gal. (L)	.08 (3)	.08 (3)	1.3 (5)	1.3 (5)	1.3 (5)	1.9 (7)
FINAL DRIVE (Each Side)	gal. (L)	.5 (2)	.5 (2)	.08 (3)	.08 (3)	.08 (3)	.08 (3)
HYDRAULIC SYSTEM	gal. (L)	45 (170)	42.5 (161)	55.5 (210)	60.8 (230)	60.8 (230)	74 (280)
HYDRAULIC TANK	gal (L)	39.6 (150)	34.3 (130)	47.8 (181)	51.5 (195)	50.2 (190)	63.4 (240)

NOTE — Where applicable, dimensions are in accordance with Society of Automotive Engineers (SAE) and ISO standards. Specifications and design are subject to change without notice. Pictures of Doosan excavators may show other than standard equipment. All dimensions are shown in inches. Respective metric dimensions are enclosed by parentheses. Doosan Construction Equipment is manufactured with a Quality Management System that is in compliance with ISO 9001:2008.

All dimensions are given for Doosan excavators equipped with standard tracks and the US20 configuration unless otherwise noted.



# Weight

## DX140LC-5

		Standard Arm (US20)	Standard Arm & Dozer Blade (US40)	Non Front (US10)
	SHOE SIZE in. (mm)	23.6 (600)	23.6 (600)	23.6 (600)
	COUNTERWEIGHT lb. (kg)	4850 (2200)	4850 (2200)	4850 (2200)
	TRACK TYPE	FIXED	FIXED	FIXED
	UNIT			
Operating Weight	lb. (kg)	32,783 (14,870)	34,987 (15,870)	29,154 (13,224)
Ground Pressure	psi (kgf/cm <sup>2</sup> )	5.4 (0.38)	5.7 (0.40)	4.8 (0.34)

## DX140LCR-5

		Standard Arm (US20)	Standard Arm & Dozer Blade (US40)	Non Front (US10)
	SHOE SIZE in. (mm)	23.6 (600)	23.6 (600)	23.6 (600)
	COUNTERWEIGHT lb. (kg)	7496 (3400)	7496 (3400)	7496 (3400)
	TRACK TYPE	FIXED	FIXED	FIXED
	UNIT			
Operating Weight	lb. (kg)	34,987 (15,870)	37,412 (16,970)	31,359 (14,224)
Ground Pressure	psi (kgf/cm <sup>2</sup> )	5.7 (0.40)	6.1 (4.3)	5.1 (0.43)

## DX180LC-5

		Standard Arm (US20)	Long Arm (US30)	Standard Arm & Dozer Blade (US40)	Standard Arm & Narrow Track (US60)	Non Front (US10)
	SHOE SIZE in. (mm)	27.6 (700)	31.5 (800)	27.6 (700)	23.6 (600)	27.6 (700)
	COUNTERWEIGHT lb. (kg)	7055 (3200)	7055 (3200)	7055 (3200)	7055 (3200)	7055 (3200)
	TRACK TYPE	FIXED	FIXED	FIXED	NARROW	FIXED
	UNIT					
Operating Weight	lb. (kg)	43,224 (19,606)	43,559 (19,758)	45,649 (20,706)	42,122 (19,106)	38,370 (17,404)
Ground Pressure	psi (kgf/cm <sup>2</sup> )	5.6 (0.40)	5.0 (0.35)	5.9 (0.42)	6.4 (0.45)	5.0 (0.35)

## DX225LC-5

		Standard Arm (US20)	Long Arm (US30)	Standard Arm & Dozer Blade (US40)	Super Long Reach (US50)	Non Front (US10)
	SHOE SIZE in. (mm)	31.5 (800)	35.4 (900)	31.5 (800)	35.4 (900)	31.5 (800)
	COUNTERWEIGHT lb. (kg)	9480 (4300)	11,684 (5300)	9480 (4300)	11,684 (5300)	9480 (4300)
	TRACK TYPE	FIXED	FIXED	FIXED	FIXED	FIXED
	UNIT					
Operating Weight	lb. (kg)	52,086 (23,626)	52,768 (23,935)	55,614 (25,226)	55,731 (25,279)	45,856 (20,800)
Ground Pressure	psi (kgf/cm <sup>2</sup> )	5.3 (0.37)	4.8 (0.34)	5.7 (0.40)	5.1 (0.36)	4.7 (0.33)

## DX235LCR-5

		Standard Arm (US20)	Standard Arm & Dozer Blade (US40)	Non Front (US10)
	SHOE SIZE in. (mm)	31.5 (800)	23.6 (600)	31.5 (800)
	COUNTERWEIGHT lb. (kg)	14,220 (6450)	14,220 (6450)	14,220 (6450)
	TRACK TYPE	FIXED	FIXED	FIXED
	UNIT			
Operating Weight	lb. (kg)	56,019 (25,410)	58,445 (26,510)	49,675 (22,532)
Ground Pressure	psi (kgf/cm <sup>2</sup> )	5.7 (0.40)	8.0 (0.56)	5.1 (0.36)

## DX255LC-5

		Standard Arm (US20)	Long Arm (US30)	Non Front (US10)
	SHOE SIZE in. (mm)	31.5 (800)	33.5 (900)	31.5 (800)
	COUNTERWEIGHT lb. (kg)	11,023 (5000)	11,023 (5000)	11,023 (5000)
	TRACK TYPE	FIXED	FIXED	FIXED
	UNIT			
Operating Weight	lb. (kg)	57,752 (26,196)	58,559 (26,562)	51,299 (23,269)
Ground Pressure	psi (kgf/cm <sup>2</sup> )	5.6 (0.40)	5.1 (0.36)	5.0 (0.35)



## Bucket

### DX140LC-5

BUCKET TYPE	MODEL	CAPACITY <sup>1</sup> yd <sup>3</sup> (m <sup>3</sup> )	WIDTH in. (mm)	WEIGHT lb. (kg)	Standard Arm (US20)		Standard Arm & Dozer Blade (US40)	
HEAVY DUTY <sup>2,3</sup>	HF40-018	0.30 (0.23)	20 (508)	772 (350)	A	A	A	A
	HF40-024	0.42 (0.32)	26 (660)	878 (398)	A	A	A	A
	HF40-030	0.56 (0.43)	32 (813)	1013 (459)	A	A	A	A
	HF40-036	0.71 (0.54)	38 (965)	1147 (520)	A	B	A	B
	HF40-042	0.85 (0.65)	44 (1118)	1253 (568)	B	C	B	C
DITCHING <sup>4</sup>	BS8B48	0.64 (0.49)	48 (1219)	602 (273)	A	B	A	A
	BS8B60	0.80 (0.61)	60 (1524)	908 (412)	B	C	A	B
HEAVY DUTY DITCHING	DX140H14BW1500	1.39 (1.06)	60 (1524)	1548 (702)	*	*	*	*

### DX140LCR-5

BUCKET TYPE	MODEL	CAPACITY <sup>1</sup> yd <sup>3</sup> (m <sup>3</sup> )	WIDTH in. (mm)	WEIGHT lb. (kg)	Standard Arm (US20)		Standard Arm & Dozer Blade (US40)	
HEAVY DUTY <sup>2,3</sup>	HF40-018	0.30 (0.23)	20 (508)	772 (350)	A	A	A	A
	HF40-024	0.42 (0.32)	26 (660)	878 (398)	A	B	A	B
	HF40-030	0.56 (0.43)	32 (813)	1013 (459)	B	C	C	C
	HF40-036	0.71 (0.54)	38 (965)	1147 (520)	C	C	C	C
	HF40-042	0.85 (0.65)	44 (1118)	1253 (568)	X	X	X	X
DITCHING <sup>4</sup>	BS8B48	0.64 (0.49)	48 (1219)	602 (273)	A	B	A	A
	BS8B60	0.80 (0.61)	60 (1524)	908 (412)	B	C	A	B
HEAVY DUTY DITCHING	DX140H14BW1500	1.39 (1.06)	60 (1524)	1548 (702)	*	*	*	*

- 1 Capacity based on ISO 7451
- 2 Equipped with Side Cutters
- 3 Equipped with Bolt On Teeth
- 4 Equipped with Bolt On Cutting Edge

Maximum Suitable Material Density  
 A 3370 lb./yd<sup>3</sup> (2000 kg/m<sup>3</sup>)  
 B 2700 lb./yd<sup>3</sup> (1600 kg/m<sup>3</sup>)  
 C 1850 lb./yd<sup>3</sup> (1100 kg/m<sup>3</sup>)  
 X Not Approved

\* Based on designed use,  
not material capacity.



# Bucket

## DX180LC-5

	Standard Arm (US20)		Long Arm (US30)		Standard Arm & Dozer Blade (US40)		Standard Arm & Narrow Track (US60)	
BOOM ft.-in. (mm)	17' (5200 mm)							
ARM ft.-in. (mm)	8' 6" (2600)		10' 2" (3100)		8' 6" (2600)		8' 6" (2600)	
SHOE SIZE in. (mm)	27.6" (700)							
TRACK TYPE	FIXED		FIXED		FIXED W/DOZER		NARROW	
MOUNT	PIN-ON	QUICK COUPLER	PIN-ON	QUICK COUPLER	PIN-ON	QUICK COUPLER	PIN-ON	QUICK COUPLER

BUCKET TYPE	MODEL	CAPACITY <sup>1</sup> yd <sup>3</sup> (m <sup>3</sup> )	WIDTH in. (mm)	WEIGHT lb. (kg)								
HEAVY DUTY <sup>2,3</sup>	HF46-018	0.38 (0.29)	20 (508)	973 (441)	A	A	A	A	A	A	A	A
	HF46-024	0.55 (0.42)	26 (660)	1107 (502)	A	A	A	A	A	A	A	A
	HF46-030	0.72 (0.55)	32 (813)	1266 (574)	A	A	A	A	A	A	A	A
	HF46-036	0.90 (0.69)	38 (965)	1424 (646)	A	A	A	B	A	A	A	A
	HF46-042	1.08 (0.83)	44 (1118)	1557 (706)	A	B	B	C	A	B	A	B
	HF46-048	1.26 (0.96)	50 (1270)	1790 (812)	B	C	B	C	A	B	B	C
DITCHING <sup>4</sup>	BS8B48	0.75 (0.57)	48 (1219)	602 (273)	A	A	A	A	A	A	A	A
	BS8B60	0.80 (0.61)	60 (1524)	908 (412)	A	A	A	A	A	A	A	A
	BS8B72	0.98 (0.75)	72 (1829)	1047 (475)	A	B	A	B	A	A	A	B
HEAVY DUTY DITCHING	H18BW1500	1.64 (1.25)	60 (1500)	1987 (901)	*	*	*	*	*	*	*	*
	H18BW1700	1.89 (1.45)	67 (1700)	2193 (995)	*	*	*	*	*	*	*	*

## DX225LC-5

	Standard Arm (US20)		Long Arm (US30)		Standard Arm & Dozer Blade (US40)		Super Long Reach (US50)
BOOM ft.-in. (mm)	18' 8" (5700)						27' 11" (8500)
ARM ft.-in. (mm)	9' 6" (2900)		11' 6" (3500)		9' 6" (2900)		20' 4" (6200)
SHOE SIZE in. (mm)	31.5" (800)		35.4" (900)		31.5" (800)		35.4" (900)
TRACK TYPE	FIXED		FIXED		FIXED W/DOZER		FIXED
MOUNT	PIN-ON	QUICK COUPLER	PIN-ON	QUICK COUPLER	PIN-ON	QUICK COUPLER	PIN-ON

BUCKET TYPE	MODEL	CAPACITY <sup>1</sup> yd <sup>3</sup> (m <sup>3</sup> )	WIDTH in. (mm)	WEIGHT lb. (kg)								
HEAVY DUTY <sup>2,3</sup>	HF49-024	0.59 (0.45)	26 (660)	1277 (579)	A	A	A	A	A	A	A	X
	HF49-030	0.78 (0.60)	32 (813)	1466 (665)	A	A	A	A	A	A	A	X
	HF49-036	0.99 (0.76)	38 (965)	1665 (755)	A	A	A	A	A	A	A	X
	HF49-042	1.20 (0.92)	44 (1118)	1820 (826)	A	A	A	B	A	A	A	X
	HF49-048	1.41 (1.08)	50 (1270)	1976 (896)	A	A	B	B	A	A	A	X
	HF40-018	0.27 (0.21)	20 (508)	796 (361)	X	X	X	X	X	X	X	A
	HF40-024	0.41 (0.31)	26 (660)	902 (409)	X	X	X	X	X	X	X	A
	HF40-030	0.55 (0.42)	32 (813)	1037 (470)	X	X	X	X	X	X	X	A
	HF40-036	0.68 (0.52)	38 (965)	1171 (531)	X	X	X	X	X	X	X	A
	HF40-042	0.82 (0.63)	44 (1118)	1253 (568)	X	X	X	X	X	X	X	B
DITCHING <sup>4</sup>	B33B48	0.93 (0.71)	48 (1219)	903 (410)	A	A	A	A	A	A	A	X
	B33B60	0.98 (0.75)	60 (1524)	1307 (593)	A	A	A	A	A	A	A	X
	B33B72	1.2 (0.92)	72 (1829)	1499 (680)	A	A	A	A	A	A	A	X
	BS8B48	0.64 (0.49)	48 (1219)	602 (273)	X	X	X	X	X	X	X	B
	BS8B60	0.80 (0.61)	60 (1524)	908 (412)	X	X	X	X	X	X	X	C
HEAVY DUTY DITCHING	H25BW1500	1.92 (1.47)	60 (1500)	2213 (1004)	*	*	*	*	*	*	*	X
	H25BW1700	2.22 (1.70)	67 (1700)	2441 (1107)	*	*	*	*	*	*	*	X
	LP25BW1850	1.67 (1.28)	73 (1850)	2153 (977)	*	*	*	*	*	*	*	X



# Specifications

## Bucket

### DX235LCR-5

	Standard Arm (US20)		Standard Arm & Dozer Blade (US40)	
BOOM ft.-in. (mm)	18' 8" (5700)			
ARM ft.-in. (mm)	9' 6" (2900)			
SHOE SIZE in. (mm)	31.5" (800)		23.6" (600)	
TRACK TYPE	FIXED		FIXED	
MOUNT	PIN-ON	QUICK COUPLER	PIN-ON	QUICK COUPLER

BUCKET TYPE	MODEL	CAPACITY <sup>1</sup> yd <sup>3</sup> (m <sup>3</sup> )	WIDTH in. (mm)	WEIGHT lb. (kg)				
HEAVY DUTY <sup>2,3</sup>	HF49-024	0.59 (0.45)	26 (660)	1277 (579)	A	A	A	A
	HF49-030	0.78 (0.60)	32 (813)	1466 (665)	A	A	A	A
	HF49-036	0.99 (0.76)	38 (965)	1665 (755)	A	A	A	A
	HF49-042	1.20 (0.92)	44 (1118)	1820 (826)	A	A	A	A
	HF49-048	1.41 (1.08)	50 (1270)	1976 (896)	A	B	A	B
DITCHING <sup>4</sup>	B33B48	0.93 (0.71)	48 (1219)	903 (410)	A	A	A	A
	B33B60	0.98 (0.75)	60 (1524)	1307 (593)	A	A	A	A
	B33B72	1.2 (0.92)	72 (1829)	1499 (680)	A	B	A	B
HEAVY DUTY DITCHING	H25BW1500	1.92 (1.47)	60 (1500)	2213 (1004)	*	*	*	*
	H25BW1700	2.22 (1.70)	67 (1700)	2441 (1107)	*	*	*	*
	LP25BW1850	1.67 (1.28)	73 (1850)	2153 (977)	*	*	*	*

### DX255LC-5

	Standard Arm (US20)		Long Arm (US30)	
BOOM ft.-in. (mm)	19' 4" (5900)			
ARM ft.-in. (mm)	9' 10" (3000)		11' 5" (3500)	
SHOE SIZE in. (mm)	31.5" (800)		35.4" (900)	
TRACK TYPE	FIXED		FIXED	
MOUNT	PIN-ON	QUICK COUPLER	PIN-ON	QUICK COUPLER

BUCKET TYPE	MODEL	CAPACITY <sup>1</sup> yd <sup>3</sup> (m <sup>3</sup> )	WIDTH in. (mm)	WEIGHT lb. (kg)				
HEAVY DUTY <sup>2,3</sup>	HF49-024	0.61 (0.47)	26 (660)	1366 (620)	A	A	A	A
	HF49-030	0.82 (0.63)	32 (813)	1555 (705)	A	A	A	A
	HF49-036	1.00 (0.76)	38 (965)	1747 (792)	A	A	A	A
	HF49-042	1.20 (0.92)	44 (1118)	1899 (861)	A	A	A	A
	HF49-048	1.45 (1.11)	50 (1270)	2048 (929)	A	A	A	A
DITCHING <sup>4</sup>	B33B48	0.93 (0.71)	48 (1219)	903 (410)	A	A	A	A
	B33B60	0.98 (0.75)	60 (1524)	1307 (593)	A	A	A	A
	B33B72	1.20 (0.92)	72 (1829)	1499 (680)	A	A	A	A
HEAVY DUTY DITCHING	DX225H25BW1500	1.92 (1.47)	60 (1500)	2224 (1009)	*	*	*	*
	DX255H25BW1700	2.22 (1.70)	67 (1700)	2452 (1112)	*	*	*	*
	DX255LP25BW1850	1.67 (1.28)	73 (1850)	2165 (982)	*	*	*	*

- 1 Capacity based on ISO 7451
- 2 Equipped with Side Cutters
- 3 Equipped with Bolt On Teeth
- 4 Equipped with Bolt On Cutting Edge

- Maximum Suitable Material Density
- A 3370 lb./yd<sup>3</sup> (2000 kg/m<sup>3</sup>)
  - B 2700 lb./yd<sup>3</sup> (1600 kg/m<sup>3</sup>)
  - C 1850 lb./yd<sup>3</sup> (1100 kg/m<sup>3</sup>)
  - X Not Approved

\* Based on designed use,  
not material capacity.



# Dimensions

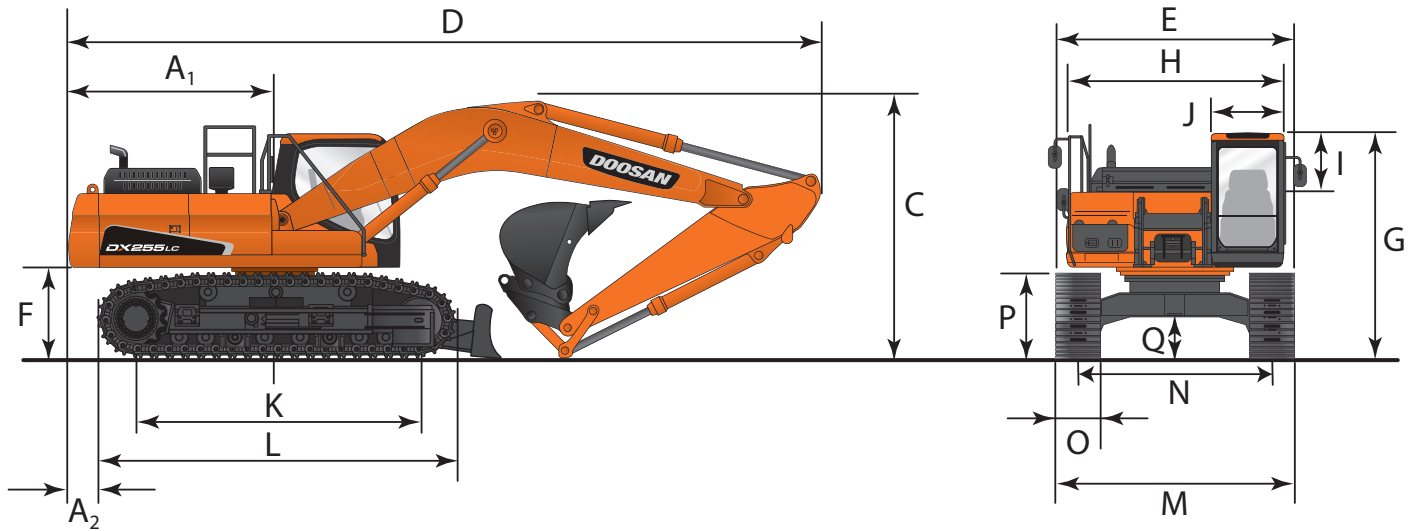

<b>DX140LC-5</b>			Standard Arm (US20)	Standard Arm & Dozer Blade (US40)
BOOM TYPE		ft.-in. (mm)	15' 1" (4600)	
ARM TYPE		ft.-in. (mm)	9' 10" (3000)	
BUCKET TYPE (SAE)		yd <sup>3</sup> (m <sup>3</sup> )	0.48 (0.37)	
TRACK TYPE			FIXED	
TAIL SWING RADIUS	A <sub>1</sub>	ft.-in. (mm)	7' 2" (2205)	
TAIL SWING OVERHANG (REAR)	A <sub>2</sub>	ft.-in. (mm)	12' 9" (328)	
TAIL SWING OVERHANG (SIDE)	A <sub>3</sub> *	ft.-in. (mm)	35.8" (910)	
SHIPPING HEIGHT (BOOM)	B	ft.-in. (mm)	10' (3065)	
SHIPPING HEIGHT (HOSE)	C	ft.-in. (mm)	10' 5" (3180)	
SHIPPING LENGTH	D	ft.-in. (mm)	25' (7640)	
SHIPPING WIDTH	E	ft.-in. (mm)	8' 5" (2590)	
COUNTERWEIGHT CLEARANCE	F	ft.-in. (mm)	35.2" (895)	
CABIN HEIGHT	G	ft.-in. (mm)	9' 1" (2785)	
UPPER STRUCTURE WIDTH	H	ft.-in. (mm)	8' 4" (2540)	
CABIN HEIGHT ABOVE HOUSE	I	ft.-in. (mm)	33.1" (840)	
CABIN WIDTH	J	ft.-in. (mm)	39.8" (1010)	
TUMBLER DISTANCE	K	ft.-in. (mm)	9' 11" (3035)	
OVERALL TRACK LENGTH	L	ft.-in. (mm)	12' 3" (3755)	
UNDERCARRIAGE WIDTH	M	ft.-in. (mm)	8' 5" (2590)	
TRACK GAUGE WIDTH	N	ft.-in. (mm)	6' 6" (1990)	
TRACK SHOE WIDTH	O	ft.-in. (mm)	23.6" (600)	
TRACK HEIGHT	P	ft.-in. (mm)	31.3" (795)	
CAR BODY CLEARANCE	Q	ft.-in. (mm)	16.1" (410)	

\* Not shown



## Dimensions

<b>DX140LCR-5</b>			Standard Arm (US20)	Standard Arm & Dozer Blade (US40)
BOOM TYPE		ft.-in. (mm)	15' 1" (4600)	
ARM TYPE		ft.-in. (mm)	9' 10" (3000)	
BUCKET TYPE (SAE)		yd <sup>3</sup> (m <sup>3</sup> )	0.51 (0.39)	
TRACK TYPE			FIXED	
TAIL SWING RADIUS	A <sub>1</sub>	ft.-in. (mm)	5' (1525)	
TAIL SWING OVERHANG (REAR)	A <sub>2</sub>	ft.-in. (mm)	-13.9" (-353)	
TAIL SWING OVERHANG (SIDE)	A <sub>3</sub> *	ft.-in. (mm)	9.1" (230)	
SHIPPING HEIGHT (BOOM)	B	ft.-in. (mm)	10' (3060)	
SHIPPING HEIGHT (HOSE)	C	ft.-in. (mm)	10' 3" (3135)	
SHIPPING LENGTH	D	ft.-in. (mm)	24' (7320)	
SHIPPING WIDTH	E	ft.-in. (mm)	8' 5" (2590)	
COUNTERWEIGHT CLEARANCE	F	ft.-in. (mm)	35.2" (895)	
CABIN HEIGHT	G	ft.-in. (mm)	9' 3" (2835)	
UPPER STRUCTURE WIDTH	H	ft.-in. (mm)	8' (2440)	
CABIN HEIGHT ABOVE HOUSE	I	ft.-in. (mm)	28.7" (730)	
CABIN WIDTH	J	ft.-in. (mm)	40.2" (1020)	
TUMBLER DISTANCE	K	ft.-in. (mm)	9' 11" (3035)	
OVERALL TRACK LENGTH	L	ft.-in. (mm)	12' 3" (3755)	
UNDERCARRIAGE WIDTH	M	ft.-in. (mm)	8' 5" (2590)	
TRACK GAUGE WIDTH	N	ft.-in. (mm)	6' 6" (1990)	
TRACK SHOE WIDTH	O	ft.-in. (mm)	23.6" (600)	
TRACK HEIGHT	P	ft.-in. (mm)	31.3" (795)	
CAR BODY CLEARANCE	Q	ft.-in. (mm)	16.1" (410)	

\* Not shown

<b>DX180LC-5</b>			Standard Arm (US20)	Long Arm (US30)	Standard Arm & Dozer Blade (US40)	Standard Arm & Narrow Track (US60)
BOOM TYPE		ft.-in. (mm)	17' 1" (5200)			
ARM TYPE		ft.-in. (mm)	8' 6" (2600)	10' 2" (3100)	8' 6" (2600)	
BUCKET TYPE (SAE)		yd <sup>3</sup> (m <sup>3</sup> )	0.92 (0.7)	0.75 (0.57)	0.92 (0.7)	
TRACK TYPE			FIXED			FIXED - NARROW
TAIL SWING RADIUS	A <sub>1</sub>	ft.-in. (mm)	8' 3" (2530)			
TAIL SWING OVERHANG (REAR)	A <sub>2</sub>	ft.-in. (mm)	19.6" (498)			
TAIL SWING OVERHANG (SIDE)	A <sub>3</sub> *	ft.-in. (mm)	42.5" (1080)	40.6" (1030)	42.5" (1080)	4' 1" (1235)
SHIPPING HEIGHT (BOOM)	B	ft.-in. (mm)	8' 11" (2725)	9' 9" (2975)	8' 11" (2725)	8' 11" (2725)
SHIPPING HEIGHT (HOSE)	C	ft.-in. (mm)	9' 4" (2855)	10' 4" (3150)	9' 4" (2855)	9' 4" (2855)
SHIPPING LENGTH	D	ft.-in. (mm)	28' 9" (8770)	29' (8845)	28' 9" (8770)	28' 9" (8770)
SHIPPING WIDTH	E	ft.-in. (mm)	9' 6" (2900)	9' 10" (3000)	9' 6" (2900)	8' 4" (2540)
COUNTERWEIGHT CLEARANCE	F	ft.-in. (mm)	40.1" (1040)			
CABIN HEIGHT	G	ft.-in. (mm)	9' 7" (2925)			
UPPER STRUCTURE WIDTH	H	ft.-in. (mm)	8' 4" (2540)			
CABIN HEIGHT ABOVE HOUSE	I	ft.-in. (mm)	33.1" (840)			
CABIN WIDTH	J	ft.-in. (mm)	39.8" (1010)			
TUMBLER DISTANCE	K	ft.-in. (mm)	10' 8" (3275)			
OVERALL TRACK LENGTH	L	ft.-in. (mm)	13' 4" (4065)			
UNDERCARRIAGE WIDTH	M	ft.-in. (mm)	9' 6" (2900)	9' 10" (3000)	9' 6" (2900)	8' 5" (2590)
TRACK GAUGE WIDTH	N	ft.-in. (mm)	7' 2" (2200)			6' 6" (1990)
TRACK SHOE WIDTH	O	in. (mm)	27.6" (700)	31.5" (800)	27.6" (700)	23.6" (600)
TRACK HEIGHT	P	ft.-in. (mm)	36" (915)			
CAR BODY CLEARANCE	Q	ft.-in. (mm)	18.1" (460)			

\* Not shown



## DX225LC-5

			Standard Arm (US20)	Long Arm (US30)	Standard Arm & Dozer Blade (US40)	Super Long Reach (US50)
BOOM TYPE	ft.-in. (mm)	18' 8" (5700)				27' 11" (8500)
ARM TYPE	ft.-in. (mm)	9' 6" (2900)	11' 6" (3500)	9' 6" (2900)	20' 4" (6200)	
BUCKET TYPE (SAE)	yd <sup>3</sup> (m <sup>3</sup> )	1.2 (0.92)	1.06 (0.81)	1.2 (0.92)	0.51 (0.39)	
TRACK TYPE		FIXED				
TAIL SWING RADIUS	A <sub>1</sub> ft.-in. (mm)	9' 2" (2795)				
TAIL SWING OVERHANG (REAR)	A <sub>2</sub> ft.-in. (mm)	22.6" (573)				
TAIL SWING OVERHANG (SIDE)	A <sub>3</sub> * ft.-in. (mm)	47.2" (1200)	45.3" (1150)	47.2" (1200)	45.3" (1150)	
SHIPPING HEIGHT (BOOM)	B ft.-in. (mm)	9' 4" (2865)	10' 3" (3130)	9' 4" (2865)	10' 5" (3185)	
SHIPPING HEIGHT (HOSE)	C ft.-in. (mm)	9' 10" (3005)	10' 11" (3330)	9' 10" (3005)	10' 8" (3275)	
SHIPPING LENGTH	D ft.-in. (mm)	31' 1" (9495)	31' 3" (9545)	31' 1" (9495)	40' 6" (12,360)	
SHIPPING WIDTH	E ft.-in. (mm)	10' 5" (3190)	10' 9" (3290)	10' 5" (3190)	10' 9" (3290)	
COUNTERWEIGHT CLEARANCE	F ft.-in. (mm)	42.9" (1090)				
CABIN HEIGHT	G ft.-in. (mm)	9' 9" (2980)				
UPPER STRUCTURE WIDTH	H ft.-in. (mm)	8' 10" (2710)				
CABIN HEIGHT ABOVE HOUSE	I ft.-in. (mm)	33.1" (840)				
CABIN WIDTH	J ft.-in. (mm)	39.8" (1010)				
TUMBLER DISTANCE	K ft.-in. (mm)	11' 11" (3650)				
OVERALL TRACK LENGTH	L ft.-in. (mm)	14' 7" (4445)				
UNDERCARRIAGE WIDTH	M ft.-in. (mm)	10' 5" (3190)	10' 9" (3290)	10' 5" (3190)	10' 9" (3290)	
TRACK GAUGE WIDTH	N ft.-in. (mm)	7' 10" (2390)				
TRACK SHOE WIDTH	O in. (mm)	31.5" (800)	35.4" (900)	31.5" (800)	35.4" (900)	
TRACK HEIGHT	P ft.-in. (mm)	37.2" (945)				
CAR BODY CLEARANCE	Q ft.-in. (mm)	18.7" (475)				

\* Not shown

## DX235LCR-5

			Standard Arm (US20)	Standard Arm & Dozer Blade (US40)
BOOM TYPE	ft.-in. (mm)	18' 8" (5700)		
ARM TYPE	ft.-in. (mm)	9' 6" (2900)		
BUCKET TYPE (SAE)	yd <sup>3</sup> (m <sup>3</sup> )	1.2 (0.92)		
TRACK TYPE		FIXED		
TAIL SWING RADIUS	A <sub>1</sub> ft.-in. (mm)	5' 6" (1680)		
TAIL SWING OVERHANG (REAR)	A <sub>2</sub> ft.-in. (mm)	-21.4" (-543)		
TAIL SWING OVERHANG (SIDE)	A <sub>3</sub> * ft.-in. (mm)	3.3" (85)	7.3" (185)	
SHIPPING HEIGHT (BOOM)	B ft.-in. (mm)	9' 4" (2870)		
SHIPPING HEIGHT (HOSE)	C ft.-in. (mm)	9' 8" (2970)		
SHIPPING LENGTH	D ft.-in. (mm)	29' 5" (8975)		
SHIPPING WIDTH	E ft.-in. (mm)	10' 5" (3190)	9' 9" (2990)	
COUNTERWEIGHT CLEARANCE	F ft.-in. (mm)	41.7" (1060)		
CABIN HEIGHT	G ft.-in. (mm)	10' 1" (3080)		
UPPER STRUCTURE WIDTH	H ft.-in. (mm)	9' 4" (2870)		
CABIN HEIGHT ABOVE HOUSE	I ft.-in. (mm)	29.9" (760)		
CABIN WIDTH	J ft.-in. (mm)	40.2" (1022)		
TUMBLER DISTANCE	K ft.-in. (mm)	11' 11" (3650)		
OVERALL TRACK LENGTH	L ft.-in. (mm)	14' 7" (4445)		
UNDERCARRIAGE WIDTH	M ft.-in. (mm)	10' 5" (3190)	9' 9" (2990)	
TRACK GAUGE WIDTH	N ft.-in. (mm)	7' 10" (2390)		
TRACK SHOE WIDTH	O in. (mm)	31.5" (800)	23.6" (600)	
TRACK HEIGHT	P ft.-in. (mm)	37.2" (945)		
CAR BODY CLEARANCE	Q ft.-in. (mm)	18.7" (475)		

\* Not shown

## DX255LC-5

			Standard Arm (US20)	Long Arm (US30)
BOOM TYPE	ft.-in. (mm)	19' 4" (5900)		
ARM TYPE	ft.-in. (mm)	9' 10" (3000)	11' 6" (3500)	
BUCKET TYPE (SAE)	yd <sup>3</sup> (m <sup>3</sup> )	1.44 (1,1)	1.2 (0.92)	
TRACK TYPE		FIXED		
TAIL SWING RADIUS	A <sub>1</sub> ft.-in. (mm)	9' 11" (3040)		
TAIL SWING OVERHANG (REAR)	A <sub>2</sub> ft.-in. (mm)	28.5 (725)		
TAIL SWING OVERHANG (SIDE)	A <sub>3</sub> * ft.-in. (mm)	4' 5" (1340)	4' 3" (1290)	
SHIPPING HEIGHT (BOOM)	B ft.-in. (mm)	9' 9" (2995)	11' 1" (3380)	
SHIPPING HEIGHT (HOSE)	C ft.-in. (mm)	10' 5" (3200)	11' 7" (3555)	
SHIPPING LENGTH	D ft.-in. (mm)	33' (10,080)	33' 1" (10,105)	
SHIPPING WIDTH	E ft.-in. (mm)	11' 1" (3400)	11' 5" (3500)	
COUNTERWEIGHT CLEARANCE	F ft.-in. (mm)	43.7" (1110)		
CABIN HEIGHT	G ft.-in. (mm)	9' 9" (2995)		
UPPER STRUCTURE WIDTH	H ft.-in. (mm)	8' 10" (2710)		
CABIN HEIGHT ABOVE HOUSE	I ft.-in. (mm)	33.1" (840)		
CABIN WIDTH	J ft.-in. (mm)	39.8" (1010)		
TUMBLER DISTANCE	K ft.-in. (mm)	12' 6" (3835)		
OVERALL TRACK LENGTH	L ft.-in. (mm)	15' 2" (4630)		
UNDERCARRIAGE WIDTH	M ft.-in. (mm)	11' 1" (3400)	11' 5" (3500)	
TRACK GAUGE WIDTH	N ft.-in. (mm)	8' 6" (2600)		
TRACK SHOE WIDTH	O in. (mm)	31.5" (800)	35.4" (900)	
TRACK HEIGHT	P ft.-in. (mm)	39" (990)		
CAR BODY CLEARANCE	Q ft.-in. (mm)	17.7" (450)		

\* Not shown



## Working Range

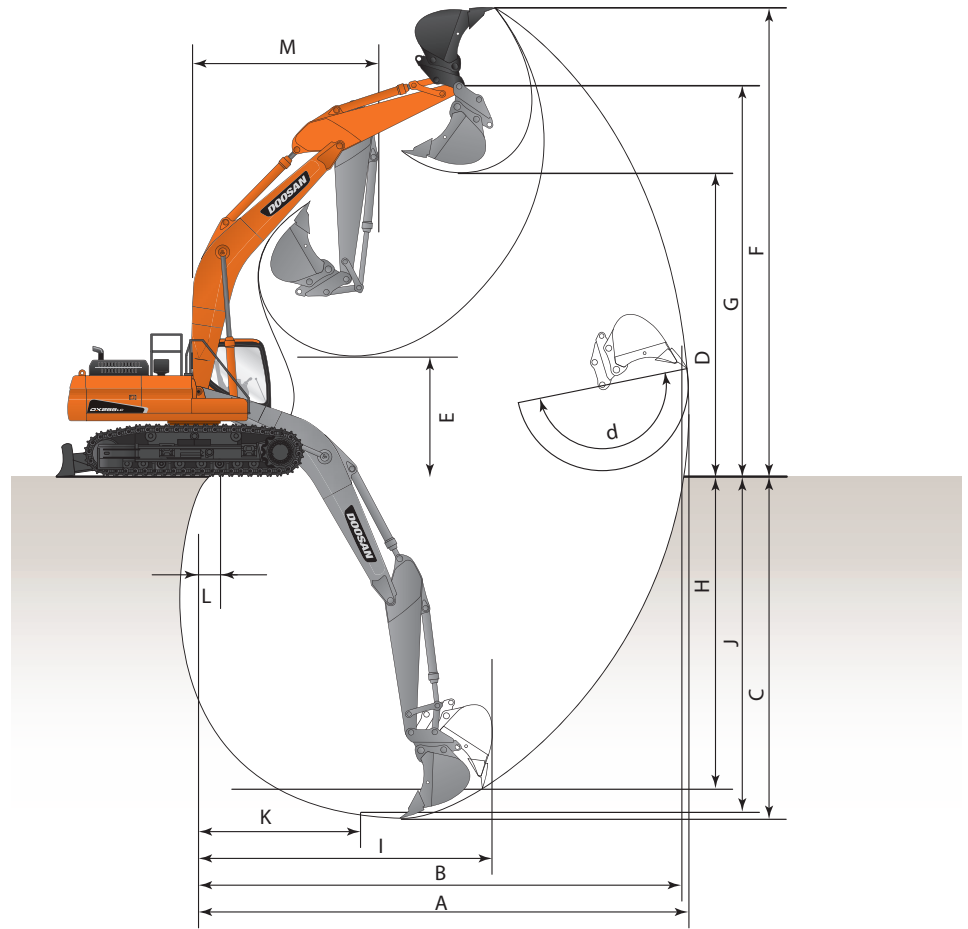

### DX140LC-5

		Standard Arm (US20)	Standard Arm & Dozer Blade (US40)
BOOM TYPE	ft.-in. (mm)	15' 1" (4600)	
ARM TYPE	ft.-in. (mm)	9' 10" (3000)	
BUCKET TYPE (SAE)	yd <sup>3</sup> (m <sup>3</sup> )	0.48 (0.37)	
TRACK TYPE		FIXED	
MAX. DIGGING REACH	A ft.-in. (mm)	28' 5" (8665)	
MAX. DIGGING REACH (GROUND)	B ft.-in. (mm)	27' 11" (8530)	
MAX. DIGGING DEPTH	C ft.-in. (mm)	20' 1" (6135)	
MAX. LOADING HEIGHT	D ft.-in. (mm)	21' 1" (6440)	
MIN. LOADING HEIGHT	E ft.-in. (mm)	5' 7" (1725)	
MAX. DIGGING HEIGHT	F ft.-in. (mm)	28' 8" (8745)	
MAX. BUCKET PIN HEIGHT	G ft.-in. (mm)	25' 1" (7655)	
MAX. VERTICAL WALL DEPTH	H ft.-in. (mm)	15' 4" (4685)	
MAX. RADIUS VERTICAL	I ft.-in. (mm)	19' 7" (5970)	
MAX. DEPTH TO 8' LINE	J ft.-in. (mm)	19' 3" (5890)	
MIN. RADIUS 8' LINE	K ft.-in. (mm)	5' 11" (1825)	
MIN. DIGGING REACH	L ft.-in. (mm)	-8" (-225)	
MIN. SWING RADIUS	M ft.-in. (mm)	8' 7" (2625)	
BUCKET ANGLE (DEG)	d Degrees	174°	

### DX140LCR-5

		Standard Arm (US20)	Standard Arm & Dozer Blade (US40)
BOOM TYPE	ft.-in. (mm)	15' 1" (4600)	
ARM TYPE	ft.-in. (mm)	9' 10" (3000)	
BUCKET TYPE (SAE)	yd <sup>3</sup> (m <sup>3</sup> )	0.51 (0.39)	
TRACK TYPE		FIXED	
MAX. DIGGING REACH	A ft.-in. (mm)	28' 5" (8665)	
MAX. DIGGING REACH (GROUND)	B ft.-in. (mm)	27' 11" (8530)	
MAX. DIGGING DEPTH	C ft.-in. (mm)	19' 7" (5985)	
MAX. LOADING HEIGHT	D ft.-in. (mm)	23' 2" (7080)	
MIN. LOADING HEIGHT	E ft.-in. (mm)	6' 11" (2120)	
MAX. DIGGING HEIGHT	F ft.-in. (mm)	31' (9470)	
MAX. BUCKET PIN HEIGHT	G ft.-in. (mm)	27' 2" (8300)	
MAX. VERTICAL WALL DEPTH	H ft.-in. (mm)	15' 4" (4680)	
MAX. RADIUS VERTICAL	I ft.-in. (mm)	19' 7" (5970)	
MAX. DEPTH TO 8' LINE	J ft.-in. (mm)	18' 10" (5765)	
MIN. RADIUS 8' LINE	K ft.-in. (mm)	6' 8" (2040)	
MIN. DIGGING REACH	L ft.-in. (mm)	-5" (-130)	
MIN. SWING RADIUS	M ft.-in. (mm)	7' 7" (2320)	
BUCKET ANGLE (DEG)	d Degrees	174°	

## DX180LC-5

			Standard Arm (US20)	Long Arm (US30)	Standard Arm & Dozer Blade (US40)	Standard Arm & Narrow Track (US60)
<b>BOOM TYPE</b>		ft.-in. (mm)	17' 1" (5200)			
<b>ARM TYPE</b>		ft.-in. (mm)	8' 6" (2600)	10' 2" (3100)	8' 6" (2600)	
<b>BUCKET TYPE (SAE)</b>		yd <sup>3</sup> (m <sup>3</sup> )	0.92 (0.7)	0.75 (0.57)	0.92 (0.7)	
<b>TRACK TYPE</b>			FIXED			FIXED - NARROW
MAX. DIGGING REACH	A	ft.-in. (mm)	30' 1" (9190)	31' 3" (9545)	30' 1" (9190)	30' 1" (9190)
MAX. DIGGING REACH (GROUND)	B	ft.-in. (mm)	29' 7" (9020)	30' 9" (9380)	29' 7" (9020)	29' 7" (9020)
MAX. DIGGING DEPTH	C	ft.-in. (mm)	20' (6110)	21' 8" (6610)	20' (6110)	20' (6110)
MAX. LOADING HEIGHT	D	ft.-in. (mm)	21' 3" (6500)	21' 3" (6500)	21' 3" (6500)	21' 3" (6500)
MIN. LOADING HEIGHT	E	ft.-in. (mm)	7' 9" (2380)	6' 2" (1880)	7' 9" (2380)	7' 9" (2380)
MAX. DIGGING HEIGHT	F	ft.-in. (mm)	30' 1" (9170)	29' 9" (9090)	30' 1" (9170)	30' 1" (9170)
MAX. BUCKET PIN HEIGHT	G	ft.-in. (mm)	25' 11" (7920)	25' 11" (7915)	25' 11" (7920)	25' 11" (7920)
MAX. VERTICAL WALL DEPTH	H	ft.-in. (mm)	16' 4" (4985)	16' 6" (5030)	16' 4" (4985)	16' 4" (4985)
MAX. RADIUS VERTICAL	I	ft.-in. (mm)	20' 2" (6165)	21' 9" (6645)	20' 2" (6165)	20' 2" (6165)
MAX. DEPTH TO 8' LINE	J	ft.-in. (mm)	19' 4" (5900)	20' 11" (6395)	19' 4" (5900)	19' 4" (5900)
MIN. RADIUS 8' LINE	K	ft.-in. (mm)	7' 11" (2435)	7' 7" (2330)	7' 11" (2435)	7' 11" (2435)
MIN. DIGGING REACH	L	ft.-in. (mm)	1' 2" (375)	-8" (-215)	1' 2" (375)	1' 2" (375)
MIN. SWING RADIUS	M	ft.-in. (mm)	10' 6" (3210)	10' 6" (3210)	10' 6" (3210)	10' 6" (3210)
BUCKET ANGLE (DEG)	d	Degrees	176°	176°	176°	176°

## DX225LC-5

			Standard Arm (US20)	Long Arm (US30)	Standard Arm & Dozer Blade (US40)	Super Long Reach (US50)
<b>BOOM TYPE</b>		ft.-in. (mm)	18' 8" (5700)			27' 11" (8500)
<b>ARM TYPE</b>		ft.-in. (mm)	9' 6" (2900)	11' 6" (3500)	9' 6" (2900)	20' 4" (6200)
<b>BUCKET TYPE (SAE)</b>		yd <sup>3</sup> (m <sup>3</sup> )	1.2 (0.92)	1.06 (0.81)	1.2 (0.92)	0.51 (0.39)
<b>TRACK TYPE</b>			FIXED			
MAX. DIGGING REACH	A	ft.-in. (mm)	32' 4" (9880)	34' 0" (10 385)	32' 4" (9880)	50' 5" (15 380)
MAX. DIGGING REACH (GROUND)	B	ft.-in. (mm)	31' 10" (9710)	33' 6" (10 215)	31' 10" (9710)	50' 0" (15 265)
MAX. DIGGING DEPTH	C	ft.-in. (mm)	21' 7" (6580)	23' 6" (7185)	21' 7" (6580)	38' 2" (11 650)
MAX. LOADING HEIGHT	D	ft.-in. (mm)	22' 5" (6840)	22' 11" (6985)	22' 5" (6840)	35' 6" (10 845)
MIN. LOADING HEIGHT	E	ft.-in. (mm)	8' 2" (2500)	6' 2" (1895)	8' 2" (2500)	6' 2" (1895)
MAX. DIGGING HEIGHT	F	ft.-in. (mm)	31' 4" (9555)	31' 8" (9660)	31' 4" (9555)	42' 10" (13 075)
MAX. BUCKET PIN HEIGHT	G	ft.-in. (mm)	27' 2" (8295)	27' 8" (8440)	27' 2" (8295)	39' 7" (12 075)
MAX. VERTICAL WALL DEPTH	H	ft.-in. (mm)	18' 5" (5620)	19' 7" (5970)	18' 5" (5620)	31' 10" (9710)
MAX. RADIUS VERTICAL	I	ft.-in. (mm)	20' 11" (6380)	22' 1" (6740)	20' 11" (6380)	33' (10 065)
MAX. DEPTH TO 8' LINE	J	ft.-in. (mm)	20' 11" (6390)	22' 11" (7005)	20' 11" (6390)	37' 1" (11 305)
MIN. RADIUS 8' LINE	K	ft.-in. (mm)	9' 3" (2820)	9' 1" (2785)	9' 3" (2820)	12' 7" (3855)
MIN. DIGGING REACH	L	ft.-in. (mm)	1' 8" (515)	-8" (-225)	1' 8" (515)	5" (150)
MIN. SWING RADIUS	M	ft.-in. (mm)	11' 8" (3560)	11' 10" (3615)	11' 11" (3650)	16' 3" (4960)
BUCKET ANGLE (DEG)	d	Degrees	177°	177°	177°	177°



## Working Range

<b>DX235LCR-5</b>			Standard Arm (US20)	Standard Arm & Dozer Blade (US40)	<b>DX255LC-5</b>			Standard Arm (US20)	Long Arm (US30)
BOOM TYPE		ft.-in. (mm)	18' 8" (5700)		BOOM TYPE		ft.-in. (mm)	19' 4" (5900)	
ARM TYPE		ft.-in. (mm)	9' 6" (2900)		ARM TYPE		ft.-in. (mm)	9' 10" (3000)	11' 6" (3500)
BUCKET TYPE (SAE)		yd <sup>3</sup> (m <sup>3</sup> )	1.2 (0.92)		BUCKET TYPE (SAE)		yd <sup>3</sup> (m <sup>3</sup> )	1.44 (1.1)	1.2 (0.92)
TRACK TYPE			FIXED		TRACK TYPE			FIXED	
MAX. DIGGING REACH	A	ft.-in. (mm)	32' 2" (9820)		MAX. DIGGING REACH	A	ft.-in. (mm)	33' 4" (10,175)	34' 9" (10,605)
MAX. DIGGING REACH (GROUND)	B	ft.-in. (mm)	31' 7" (9630)		MAX. DIGGING REACH (GROUND)	B	ft.-in. (mm)	32' 9" (9995)	34' 2" (10,430)
MAX. DIGGING DEPTH	C	ft.-in. (mm)	21' 10" (6670)		MAX. DIGGING DEPTH	C	ft.-in. (mm)	22' 4" (6810)	23' 11" (7315)
MAX. LOADING HEIGHT	D	ft.-in. (mm)	26' (7950)		MAX. LOADING HEIGHT	D	ft.-in. (mm)	23' (7025)	23' 6" (7170)
MIN. LOADING HEIGHT	E	ft.-in. (mm)	10' 4" (3150)		MIN. LOADING HEIGHT	E	ft.-in. (mm)	8' 6" (2600)	6' 10" (2090)
MAX. DIGGING HEIGHT	F	ft.-in. (mm)	35' 5" (10,795)		MAX. DIGGING HEIGHT	F	ft.-in. (mm)	31' 10" (9705)	32' 2" (9820)
MAX. BUCKET PIN HEIGHT	G	ft.-in. (mm)	30' 10" (9405)		MAX. BUCKET PIN HEIGHT	G	ft.-in. (mm)	27' 10" (8500)	28' 4" (8640)
MAX. VERTICAL WALL DEPTH	H	ft.-in. (mm)	17' 5" (5325)		MAX. VERTICAL WALL DEPTH	H	ft.-in. (mm)	17' (5200)	18' 1" (5520)
MAX. RADIUS VERTICAL	I	ft.-in. (mm)	21' 6" (6575)		MAX. RADIUS VERTICAL	I	ft.-in. (mm)	23' 8" (7225)	24' 8" (7520)
MAX. DEPTH TO 8" LINE	J	ft.-in. (mm)	21' 1" (6445)		MAX. DEPTH TO 8" LINE	J	ft.-in. (mm)	21' 8" (6615)	23' 4" (7135)
MIN. RADIUS 8" LINE	K	ft.-in. (mm)	8' 4" (2565)		MIN. RADIUS 8" LINE	K	ft.-in. (mm)	9' 7" (2930)	9' 7" (2945)
MIN. DIGGING REACH	L	ft.-in. (mm)	1' 3" (395)		MIN. DIGGING REACH	L	ft.-in. (mm)	2' 3" (690)	7" (190)
MIN. SWING RADIUS	M	ft.-in. (mm)	7' 6" (2310)		MIN. SWING RADIUS	M	ft.-in. (mm)	12' 2" (3720)	12' 3" (3745)
BUCKET ANGLE (DEG)	d	Degrees	177°		BUCKET ANGLE (DEG)	d	Degrees	174°	

## Hydraulic Cylinders

	UNIT	DX140LC-5	DX140LCR-5	DX180LC-5	DX225LC-5	DX235LC-5	DX255LC-5
<b>BOOM (2)</b>							
BORE x ROD DIAMETER x STROKE (STD & SLR*)	in. x in. x in. (mm x mm x mm)	4.3 x 3.0 x 42.7 (110 x 75 x 1085)	4.3 x 3.0 x 43.4 (110 x 75 x 1103)	4.5 x 3.1 x 47.1 (115 x 80 x 1195)	4.9 x 3.4 x 49.7 (125 x 85 x 1263)	5.1 x 3.5 x 53.3 (130 x 90 x 1355)	5.1 x 3.5 x 53.7 (130 x 90 x 1365)
<b>ARM (1)</b>							
BORE x ROD DIAMETER x STROKE (STD & SLR*)	in. x in. x in. (mm x mm x mm)	4.5 x 3.1 x 43.6 (115 x 80 x 1108)	4.5 x 3.1 x 43.6 (115 x 80 x 1108)	4.9 x 3.5 x 57.9 (125 x 90 x 1470)	5.5 x 3.9 x 57.1 (140 x 100 x 1450)	5.3 x 3.7 x 58.7 (135 x 95 x 1490)	5.5 x 3.9 x 65.2 (140 x 100 x 1655)
<b>BUCKET (1)</b>							
BORE x ROD DIAMETER x STROKE (STD)	in. x in. x in. (mm x mm x mm)	3.9 x 2.8 x 35.4 (100 x 70 x 900)	3.9 x 2.8 x 35.4 (100 x 70 x 900)	4.3 x 2.9 x 40.4 (110 x 75 x 1025)	4.7 x 3.1 x 41.7 (120 x 80 x 1060)	4.7 x 3.1 x 41.7 (120 x 80 x 1060)	4.9 x 3.4 x 42.5 (125 x 85 x 1080)
BORE x ROD DIAMETER x STROKE (SLR*)	in. x in. x in. (mm x mm x mm)	-	-	-	3.7 x 2.6 x 35.4 (95 x 65 x 900)	-	-

The piston rods and cylinder bodies are made of high-strength steel. A shock-absorbing mechanism is fitted in all cylinders to ensure shock-free operation and extend piston life. \* = Applicable to SLR (Super Long Reach) machines only.

# Digging Force (ISO)

<b>DX140LC-5</b>		Standard Arm (US20)	Standard Arm & Dozer Blade (US40)
DIGGING FORCE (PCSA)	BUCKET SIZE (SAE) yd <sup>3</sup> (m <sup>3</sup> )	0.55 (0.42)	0.55 (0.42)
	UNIT		
	lbf.	21,471	21,471
	kgf	11,100	11,100
	kN	109	109
ARM FORCE	ARM ft.-in. (mm)	9' 10" (3000)	9' 10" (3000)
	UNIT		
	lbf.	13,228	13,228
	kgf	6000	6000
	kN	59	59

<b>DX140LCR-5</b>		Standard Arm (US20)	Standard Arm & Dozer Blade (US40)
DIGGING FORCE (PCSA)	BUCKET SIZE (SAE) yd <sup>3</sup> (m <sup>3</sup> )	0.55 (0.42)	0.55 (0.42)
	UNIT		
	lbf.	21,471	21,471
	kgf	11,100	11,100
	kN	109	109
ARM FORCE	ARM ft.-in. (mm)	9' 10" (3000)	9' 10" (3000)
	UNIT		
	lbf.	13,228	13,228
	kgf	6000	6000
	kN	59	59

<b>DX180LC-5</b>		Standard Arm (US20)	Long Arm (US30)	Standard Arm & Dozer Blade (US40)	Standard Arm & Narrow Track (US60)
DIGGING FORCE (PCSA)	BUCKET SIZE (SAE) yd <sup>3</sup> (m <sup>3</sup> )	1.02 (0.78)	0.72 (0.55)	1.02 (0.78)	1.02 (0.79)
	UNIT				
	lbf.	28,881	28,881	28,881	28,881
	kgf	13,100	13,100	13,100	13,100
	kN	128	128	128	128
ARM FORCE	ARM ft.-in. (mm)	8' 6" (2600)	10' 2" (3100)	8' 6" (2600)	8' 6" (2600)
	UNIT				
	lbf.	20,503	18,960	20,503	20,503
	kgf	9300	8600	9300	9300
	kN	91	84	91	91

<b>DX225LC-5</b>		Standard Arm (US20)	Long Arm (US30)	Standard Arm & Dozer Blade (US40)	Super Long Reach (US50)
DIGGING FORCE (PCSA)	BUCKET SIZE (SAE) yd <sup>3</sup> (m <sup>3</sup> )	1.20 (0.92)	1.06 (0.81)	1.20 (0.92)	0.51 (0.39)
	UNIT				
	lbf.	33,510	33,510	33,510	22,046
	kgf	15,200	15,200	15,200	10,000
	kN	149	149	149	98
ARM FORCE	ARM ft.-in. (mm)	9' 6" (2900)	11' 6" (3500)	9' 6" (2900)	20' 4" (6200)
	UNIT				
	lbf.	23,810	21,385	23,810	13,228
	kgf	10,800	9700	10,800	6000
	kN	106	95	106	59

<b>DX235LCR-5</b>		Standard Arm (US20)	Standard Arm & Dozer Blade (US40)
DIGGING FORCE (PCSA)	BUCKET SIZE (SAE) yd <sup>3</sup> (m <sup>3</sup> )	1.20 (0.92)	1.20 (0.92)
	UNIT		
	lbf.	35,274	35,274
	kgf	16,000	16,000
	kN	157	157
ARM FORCE	ARM ft.-in. (mm)	9' 6" (2900)	9' 6" (2900)
	UNIT		
	lbf.	24,471	24,471
	kgf	11,100	11,100
	kN	109	109

<b>DX255LC-5</b>		Standard Arm (US20)	Long Arm (US30)
DIGGING FORCE (PCSA)	BUCKET SIZE (SAE) yd <sup>3</sup> (m <sup>3</sup> )	1.44 (1.10)	1.20 (0.92)
	UNIT		
	lbf.	37,479	37,479
	kgf	17,900	17,900
	kN	176	176
ARM FORCE	ARM ft.-in. (mm)	9' 10" (3000)	11' 5" (3500)
	UNIT		
	lbf.	28,219	25,794
	kgf	12,800	11,700
	kN	126	115



## Lifting Capacity

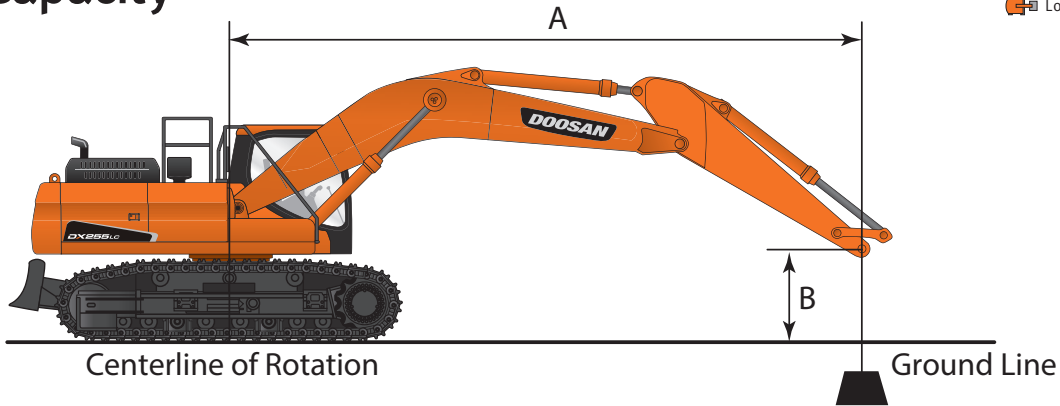
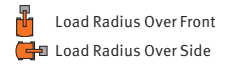

### DX140LC-5 STANDARD ARM (US20)

Track Width: 8' 6" (2590 mm) Boom: 15' 1" (4600 mm) Arm: 9' 10" (3000 mm) Bucket: None Shoe Width: 23.6" (600 mm) Counterweight: 4850 lb. (2200 kg) Unit: 1000 lb. (1000 kg)

B (ft.) \ A (ft.)	5		10		15		20		MAX F	MAX S	MAX REACH
	Front	Side	Front	Side	Front	Side	Front	Side	Front	Side	A (ft)
25									5.47 *	5.47 *	13.62
20									4.54 *	4.54 *	19.15
15					7.34 *	7.34 *	6.81 *	5.1	4.28 *	4.22	22.25
10			11.57 *	11.57 *	9.50 *	7.75	7.73	4.93	4.31 *	3.65	23.91
5			19.13 *	13.16	11.7	7.18	7.46	4.69	4.59 *	3.42	24.44
0 (GROUND)			19.27 *	12.19	11.18	6.73	7.23	4.47	5.17 *	3.45	23.91
-5	11.62 *	11.62 *	22.37	11.95	10.95	6.52	7.12	4.37	6.13	3.79	22.25
-10	18.42 *	18.42 *	22.50 *	12.1	10.99	6.55			7.66	4.72	19.14
-15			16.83 *	12.64					11.85 *	7.96	13.59

B (m) \ A (m)	1.5		3		4.5		6		MAX F	MAX S	MAX REACH
	Front	Side	Front	Side	Front	Side	Front	Side	Front	Side	A (m)
7.5									2.42 *	2.42 *	4.34
6									2.05 *	2.05 *	5.91
4.5					3.35 *	3.35 *	3.20 *	2.37	1.94 *	1.9	6.81
3			5.40 *	5.40 *	4.38 *	3.59	3.59	2.29	1.96 *	1.65	7.3
1.5			8.90 *	6.11	5.44	3.33	3.47	2.18	2.08 *	1.55	7.45
0 (GROUND)			8.35 *	5.67	5.2	3.12	3.36	2.08	2.34 *	1.57	7.29
-1.5	5.20 *	5.20 *	10.12 *	5.56	5.09	3.02	3.3	2.03	2.77	1.72	6.79
-3	8.19 *	8.19 *	10.41 *	5.63	5.11	3.04			3.44	2.12	5.87
-4.5			7.94 *	5.87					5.36 *	3.47	4.25

\*Hydraulically Limited

- Load point is the end of the arm.
- Capacities marked with an asterisk (\*) are limited by hydraulic capacities.
- Lift capacities shown do not exceed 75% of minimum tipping loads or 87% of hydraulic capacities
- The least stable position is over the side.
- The total mass of machine includes the mass of the boom, arm, counterweight, all operating fluids and 165 lb. (75 kg) operator.
- Lift Capacities are in compliance with ISO 10567.

# Lifting Capacity

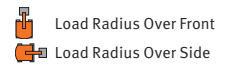

## DX140LC-5 STANDARD ARM & DOZER BLADE (US40)

Track Width: 8' 6" (2590 mm)    Boom: 15' 1" (4600 mm)    Arm: 9' 10" (3000 mm)    Bucket: None    Shoe Width: 23.6" (600 mm)    Counterweight: 4850 lb. (2200 kg)    Unit: 1000 lb. (1000 kg)

A (ft.) \ B (ft.)	5		10		15		20		MAX F	MAX S	MAX REACH
											A (ft)
25									5.47 *	5.47 *	13.62
20									4.54 *	4.54 *	19.15
15					7.34 *	7.34 *	6.81 *	5.43	4.28 *	4.28 *	22.25
10			11.57 *	11.57 *	9.50 *	8.23	8.64 *	5.26	4.31 *	3.92	23.91
5			19.13 *	14.01	12.38 *	7.66	8.52	5.02	4.59 *	3.69	24.44
0 (GROUND)			19.27 *	13.04	12.77	7.21	8.29	4.81	5.17 *	3.72	23.91
-5	11.62 *	11.62 *	23.14 *	12.8	12.53	7	8.17	4.71	6.31 *	4.08	22.25
-10	18.42 *	18.42 *	22.50 *	12.95	12.57	7.03			8.78	5.07	19.14
-15			16.83 *	13.49					11.85 *	8.5	13.59

A (m) \ B (m)	1.5		3		4.5		6		MAX F	MAX S	MAX REACH
											A (m)
7.5									2.42 *	2.42 *	4.34
6									2.05 *	2.05 *	5.91
4.5					3.35 *	3.35 *	3.20 *	2.53	1.94 *	1.94 *	6.81
3			5.40 *	5.40 *	4.38 *	3.82	3.95 *	2.44	1.96 *	1.77	7.3
1.5			8.90 *	6.5	5.72 *	3.55	3.96	2.33	2.08 *	1.67	7.45
0 (GROUND)			8.35 *	6.06	5.94	3.34	3.85	2.23	2.34 *	1.69	7.29
-1.5	5.20 *	5.20 *	10.12 *	5.96	5.83	3.25	3.79	2.18	2.85 *	1.85	6.79
-3	8.19 *	8.19 *	10.41 *	6.03	5.84	3.26			3.94	2.28	5.87
-4.5			7.94 *	6.26					5.36 *	3.71	4.25

\*Hydraulically Limited



## Lifting Capacity

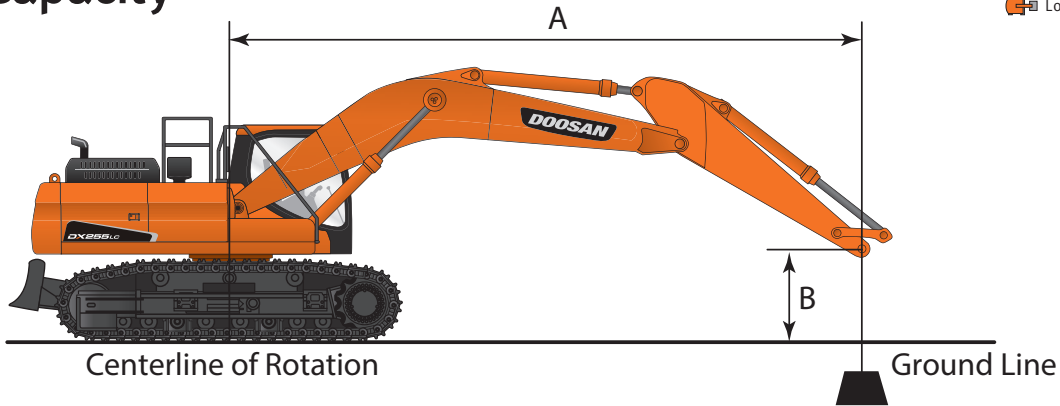
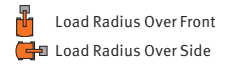

### DX140LCR-5 STANDARD ARM (US20)

Track Width: 8' 6" (2590 mm) Boom: 15' 1" (4600 mm) Arm: 9' 10" (3000 mm) Bucket: None Shoe Width: 23.6" (600 mm) Counterweight: 7496 lb. (3400 kg) Unit: 1000 lb. (1000 kg)

B (ft.) \ A (ft.)	5		10		15		20		MAX F	MAX S	MAX REACH
											A (ft)
25									5.47 *	5.47 *	13.62
20					7.16 *	7.16 *			4.54 *	4.54 *	19.17
15					7.81 *	7.81 *	6.81 *	5.43	4.28 *	4.28 *	22.25
10			12.16 *	12.16 *	10.32 *	8.23	8.27	5.26	4.31 *	3.92	23.91
5			19.98 *	14.02	12.52	7.66	8.01	5.02	4.59 *	3.69	24.44
0 (GROUND)			19.27 *	13.04	12	7.21	7.77	4.81	5.17 *	3.72	23.91
-5	11.64 *	11.64 *	23.16 *	12.8	11.76	7	7.66	4.7	6.32 *	4.08	22.24
-10	18.44 *	18.44 *	20.62 *	12.95	11.8	7.03			8.24	5.07	19.14
-15			13.87 *	13.49					9.70 *	8.49	13.61

B (m) \ A (m)	1.5		3		4.5		6		MAX F	MAX S	MAX REACH
											A (m)
7.5									2.42 *	2.42 *	4.34
6					3.28 *	3.28 *			2.05 *	2.05 *	5.91
4.5					3.56 *	3.56 *	3.21 *	2.53	1.94 *	1.94 *	6.82
3			5.82 *	5.82 *	4.76 *	3.82	3.85	2.45	1.96 *	1.77	7.3
1.5			9.28 *	6.51	5.82	3.55	3.72	2.33	2.08 *	1.67	7.45
0 (GROUND)			8.35 *	6.06	5.58	3.34	3.61	2.23	2.35 *	1.69	7.29
-1.5	5.20 *	5.20 *	10.13 *	5.96	5.47	3.25	3.56	2.18	2.86 *	1.85	6.79
-3	8.20 *	8.20 *	9.55 *	6.03	5.48	3.26			3.71	2.28	5.87
-4.5			6.60 *	6.26					4.42 *	3.72	4.24

\*Hydraulically Limited

- Load point is the end of the arm.
- Capacities marked with an asterisk (\*) are limited by hydraulic capacities.
- Lift capacities shown do not exceed 75% of minimum tipping loads or 87% of hydraulic capacities
- The least stable position is over the side.
- The total mass of machine includes the mass of the boom, arm, counterweight, all operating fluids and 165 lb. (75 kg) operator.
- Lift Capacities are in compliance with ISO 10567.

# Lifting Capacity

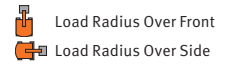

## DX140LCR-5 STANDARD ARM & DOZER BLADE (US40)

Track Width: 8' 6" (2590 mm)    Boom: 15' 1" (4600 mm)    Arm: 9' 10" (3000 mm)    Bucket: None    Shoe Width: 23.6" (600 mm)    Counterweight: 7496 lb. (3400 kg)    Unit: 1000 lb. (1000 kg)

B (ft.) \ A (ft.)	5		10		15		20		MAX F	MAX S	MAX REACH
											A (ft)
25									5.47 *	5.47 *	13.62
20					7.16 *	7.16 *			4.54 *	4.54 *	19.17
15					7.81 *	7.81 *	6.81 *	5.77	4.28 *	4.28 *	22.25
10			12.16 *	12.16 *	10.32 *	8.71	8.65 *	5.6	4.31 *	4.19	23.91
5			19.98 *	14.87	12.93 *	8.14	9.06	5.36	4.59 *	3.95	24.44
0 (GROUND)			19.27 *	13.89	13.58	7.69	8.83	5.14	5.17 *	4	23.91
-5	11.64 *	11.64 *	23.16 *	13.66	13.34	7.48	8.72	5.04	6.32 *	4.38	22.24
-10	18.44 *	18.44 *	20.62 *	13.8	13.38	7.51			9.02 *	5.42	19.14
-15			13.87 *	13.87 *					9.70 *	9.03	13.61

B (m) \ A (m)	1.5		3		4.5		6		MAX F	MAX S	MAX REACH
											A (m)
7.5									2.42 *	2.42 *	4.34
6					3.28 *	3.28 *			2.05 *	2.05 *	5.91
4.5					3.56 *	3.56 *	3.21 *	2.68	1.94 *	1.94 *	6.82
3			5.82 *	5.82 *	4.76 *	4.04	4.03 *	2.6	1.96 *	1.9	7.3
1.5			9.28 *	6.9	5.97 *	3.77	4.21	2.49	2.08 *	1.79	7.45
0 (GROUND)			8.35 *	6.46	6.32	3.57	4.1	2.39	2.35 *	1.81	7.29
-1.5	5.20 *	5.20 *	10.13 *	6.35	6.2	3.47	4.04	2.34	2.86 *	1.98	6.79
-3	8.20 *	8.20 *	9.55 *	6.42	6.22	3.48			4.04 *	2.44	5.87
-4.5			6.60 *	6.60 *					4.42 *	3.96	4.24

\*Hydraulically Limited



## Lifting Capacity

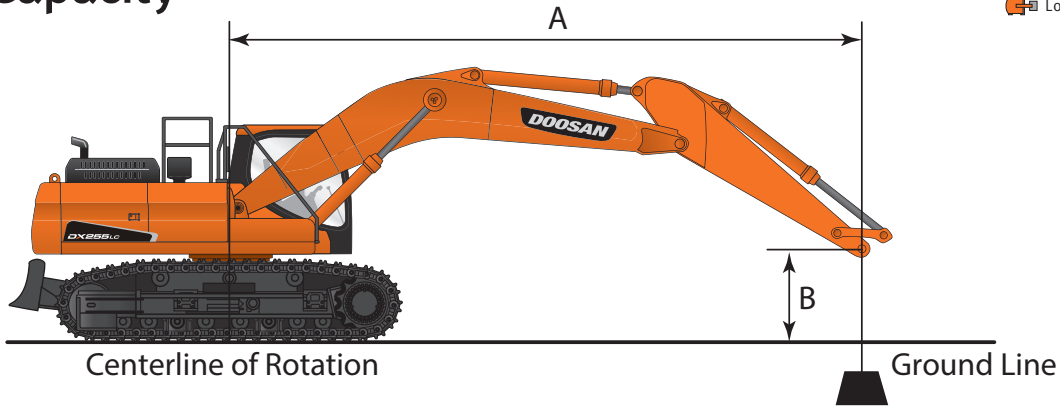
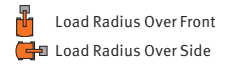

### DX180LC-5 STANDARD ARM (US20)

Track Width: 9' 6" (2900 mm)    Boom: 17' 0" (5200 mm)    Arm: 8' 6" (2600 mm)    Bucket: None    Shoe Width: 27.6" (700 mm)    Counterweight: 7055 lb. (3200 kg)    Unit: 1000 lb. (1000 kg)

B (ft.) \ A (ft.)	5		10		15		20		25		MAX REACH		A (ft)		
25													7.55 *	7.55 *	16.37
20							9.12 *	8.44					6.56 *	6.56 *	21
15					12.43 *	12.43 *	11.07 *	8.31					6.25 *	6.25	23.7
10			23.52 *	22.87	15.27 *	12.25	12.21 *	7.97	6.92 *	5.61			6.31 *	5.56	25.13
5					18.04 *	11.4	12.05	7.59	8.61	5.47			6.67 *	5.31	25.49
0 (GROUND)			15.19 *	15.19 *	18.27	10.9	11.74	7.31					7.45 *	5.43	24.83
-5	14.89 *	14.89 *	25.15 *	20.28	18.11	10.77	11.64	7.22					8.95 *	5.99	23.09
-10	25.61 *	25.61 *	22.89 *	20.67	16.32 *	10.92							11.09 *	7.45	19.92
-15													11.09 *	11.09 *	13.13

B (m) \ A (m)	1.5		3		4.5		6		7.5		MAX REACH		A (m)		
7.5													3.37 *	3.37 *	5.13
6							4.50 *	3.94					2.96 *	2.96 *	6.47
4.5					5.73 *	5.73 *	5.07 *	3.86					2.83 *	2.81	7.25
3			11.03 *	10.6	7.07 *	5.67	5.62 *	3.7	3.91 *	2.61			2.86 *	2.52	7.67
1.5					8.35 *	5.28	5.59	3.52	4	2.54			3.03 *	2.41	7.77
0 (GROUND)			6.61 *	6.61 *	8.51	5.06	5.45	3.39	3.95	2.49			3.38 *	2.46	7.57
-1.5	6.66 *	6.66 *	11.05 *	9.46	8.43	5	5.4	3.35					4.05 *	2.71	7.05
-3	11.39 *	11.39 *	10.59 *	9.63	7.58 *	5.07	5.26 *	3.42					5.04 *	3.34	6.11
-4.5													4.46 *	4.46 *	4.45

\*Hydraulically Limited

- Load point is the end of the arm.
- Capacities marked with an asterisk (\*) are limited by hydraulic capacities.
- Lift capacities shown do not exceed 75% of minimum tipping loads or 87% of hydraulic capacities
- The least stable position is over the side.
- The total mass of machine includes the mass of the boom, arm, counterweight, all operating fluids and 165 lb. (75 kg) operator.
- Lift Capacities are in compliance with ISO 10567.

# Lifting Capacity

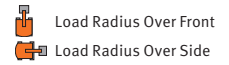

## DX180LC-5 LONG ARM (US30)

Track Width: 9' 10" (3000 mm) Boom: 17' 0" (5200 mm) Arm: 10' 2" (23100 mm) Bucket: None Shoe Width: 31.5" (800 mm) Counterweight: 7055 lb. (3200 kg) Unit: 1000 lb. (1000 kg)

B (ft.) \ A (ft.)	5		10		15		20		25		MAX REACH		A (ft)	
25												6.79 *	6.79 *	18.59
20							9.55 *	8.94				6.19 *	6.19 *	22.61
15							10.25 *	8.72	7.12 *	6		6.05 *	5.81	25.04
10			20.96 *	20.96 *	14.27 *	12.88	11.58 *	8.32	9.15	5.85		6.21 *	5.22	26.34
5			17.81 *	17.81 *	17.39 *	11.9	12.54	7.86	8.93	5.65		6.64 *	4.99	26.66
0 (GROUND)			17.66 *	17.66 *	18.99	11.25	12.14	7.51	8.75	5.48		7.46 *	5.06	26.04
-5	14.77 *	14.77 *	24.49 *	20.73	18.69	10.99	11.95	7.34				8.8	5.5	24.4
-10	23.02 *	23.02 *	25.35 *	21.03	17.63 *	11.06	12.02	7.4				10.61	6.6	21.51
-15			18.43 *	18.43 *	12.86 *	11.48						10.62 *	9.65	16.74

B (m) \ A (m)	1.5		3		4.5		6		7.5		MAX REACH		A (m)	
7.5												3.08 *	3.08 *	5.67
6							4.33 *	4.06				2.81 *	2.81 *	6.89
4.5							4.65 *	3.96	3.23 *	2.72		2.75 *	2.64	7.63
3			9.51 *	9.51 *	6.47 *	5.84	5.25 *	3.77	4.15	2.65		2.82 *	2.37	8.03
1.5			8.08 *	8.08 *	7.89 *	5.4	5.69	3.57	4.05	2.56		3.01 *	2.26	8.12
0 (GROUND)			8.01 *	8.01 *	8.61	5.1	5.51	3.41	3.97	2.49		3.39 *	2.29	7.94
-1.5	6.70 *	6.70 *	11.11 *	9.4	8.48	4.99	5.42	3.33				3.99	2.49	7.44
-3	10.44 *	10.44 *	11.50 *	9.54	8.00 *	5.02	5.45	3.36				4.81	2.99	6.56
-4.5			8.36 *	8.36 *	5.83 *	5.21						4.82 *	4.38	5.1

\*Hydraulically Limited



## Lifting Capacity

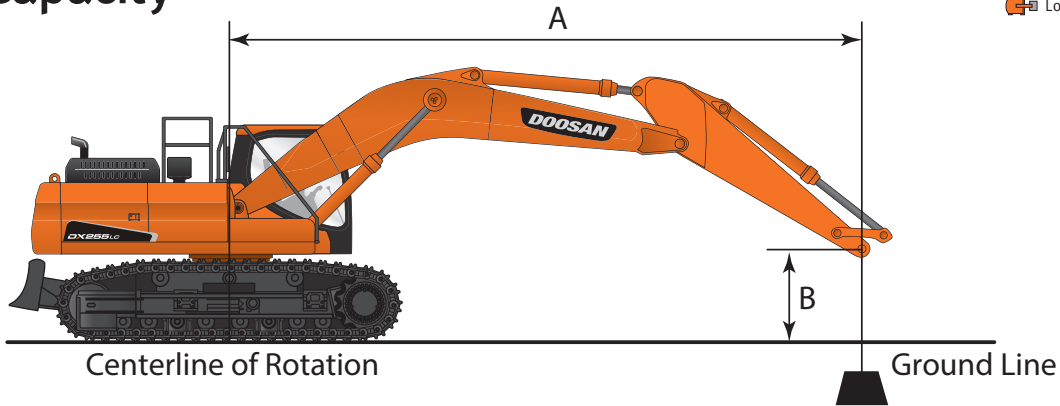
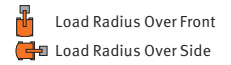

### DX180LC-5 STANDARD ARM & DOZER BLADE (US40)

Track Width: 9' 6" (2900 mm)    Boom: 17' 0" (5200 mm)    Arm: 8' 6" (2600 mm)    Bucket: None    Shoe Width: 27.6" (700 mm)    Counterweight: 7055 lb. (3200 kg)    Unit: 1000 lb. (1000 kg)

B (ft.) \ A (ft.)	5		10		15		20		25		MAX REACH		A (ft)		
	Front	Side	Front	Side	Front	Side	Front	Side	Front	Side	Front	Side			
25													7.43 *	7.43 *	16.82
20							9.92 *	9.08					6.52 *	6.52 *	21.21
15					12.64 *	12.64 *	11.17 *	8.91					6.25 *	6.25 *	23.8
10			24.31 *	24.31 *	15.59 *	13.09	12.39 *	8.55	8.62 *	6.06			6.31 *	5.84	25.15
5					18.40 *	12.23	11.96	8.16	8.54	5.91			6.68 *	5.6	25.49
0 (GROUND)			14.58 *	14.58 *	18.18	11.73	11.65	7.88	8.42	5.8			7.45 *	5.73	24.83
-5	14.67 *	14.67 *	24.35 *	21.91	18.02	11.6	11.54	7.78					8.92 *	6.31	23.12
-10	25.11 *	25.11 *	23.34 *	22.3	16.70 *	11.75	11.59 *	7.94					11.11 *	7.76	20.05
-15													9.84 *	9.84 *	14.62

B (m) \ A (m)	1.5		3		4.5		6		7.5		MAX REACH		A (m)		
	Front	Side	Front	Side	Front	Side	Front	Side	Front	Side	Front	Side			
7.5													3.37 *	3.37 *	5.13
6							4.50 *	4.22					2.96 *	2.96 *	6.47
4.5					5.73 *	5.73 *	5.07 *	4.15					2.83 *	2.83 *	7.25
3			11.03 *	11.03 *	7.07 *	6.09	5.62 *	3.98	3.91 *	2.83			2.86 *	2.73	7.67
1.5					8.35 *	5.7	5.56	3.81	3.97	2.76			3.03 *	2.62	7.77
0 (GROUND)			6.61 *	6.61 *	8.45	5.48	5.41	3.68	3.92	2.71			3.38 *	2.68	7.57
-1.5	6.66 *	6.66 *	11.05 *	10.22	8.38	5.41	5.36	3.63					4.05 *	2.95	7.05
-3	11.39 *	11.39 *	10.59 *	10.39	7.58 *	5.48	5.26 *	3.71					5.04 *	3.63	6.11
-4.5													4.46 *	4.46 *	4.45

\*Hydraulically Limited

- Load point is the end of the arm.
- Capacities marked with an asterisk (\*) are limited by hydraulic capacities.
- Lift capacities shown do not exceed 75% of minimum tipping loads or 87% of hydraulic capacities
- The least stable position is over the side.
- The total mass of machine includes the mass of the boom, arm, counterweight, all operating fluids and 165 lb. (75 kg) operator.
- Lift Capacities are in compliance with ISO 10567.

# Lifting Capacity

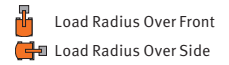

## DX180LC-5 STANDARD ARM & NARROW TRACK (US60)

Track Width: 8' 6" (2590 mm) Boom: 17' 0" (5200 mm) Arm: 8' 6" (2590 mm) Bucket: None Shoe Width: 23.6" (600 mm) Counterweight: 7055 lb. (3200 kg) Unit: 1000 lb. (1000 kg)

B (ft.) \ A (ft.)	5		10		15		20		25		MAX REACH		A (ft)
25											7.55 *	7.55 *	16.37
20							9.12 *	8.23			6.56 *	6.56 *	21
15					12.43 *	12.43 *	11.07 *	8.1			6.25 *	6.08	23.7
10			23.52 *	22.33	15.27 *	11.95	12.12	7.76	6.92 *	5.45	6.31 *	5.4	25.13
5					18.04 *	11.1	11.7	7.38	8.35	5.31	6.67 *	5.16	25.49
0 (GROUND)			15.19 *	15.19 *	17.75	10.6	11.39	7.11			7.45 *	5.27	24.83
-5	14.89 *	14.89 *	25.15 *	19.74	17.58	10.46	11.29	7.01			8.95 *	5.81	23.09
-10	25.61 *	25.61 *	22.89 *	20.13	16.32 *	10.62					11.09 *	7.24	19.92
-15											11.09 *	11.09 *	13.13

B (m) \ A (m)	1.5		3		4.5		6		7.5		MAX REACH		A (m)
7.5											3.37 *	3.37 *	5.13
6							4.50 *	3.84			2.96 *	2.96 *	6.47
4.5					5.73 *	5.73 *	5.07 *	3.76			2.83 *	2.74	7.25
3			11.03 *	10.34	7.07 *	5.54	5.62 *	3.6	3.91 *	2.54	2.86 *	2.44	7.67
1.5					8.35 *	5.14	5.43	3.42	3.88	2.47	3.03 *	2.34	7.77
0 (GROUND)			6.61 *	6.61 *	8.26	4.92	5.29	3.29	3.83	2.42	3.38 *	2.39	7.57
-1.5	6.66 *	6.66 *	11.05 *	9.2	8.19	4.86	5.24	3.25			4.05 *	2.63	7.05
-3	11.39 *	11.39 *	10.59 *	9.38	7.58 *	4.93	5.26 *	3.32			5.04 *	3.25	6.11
-4.5											4.46 *	4.46 *	4.45

\*Hydraulically Limited



## Lifting Capacity

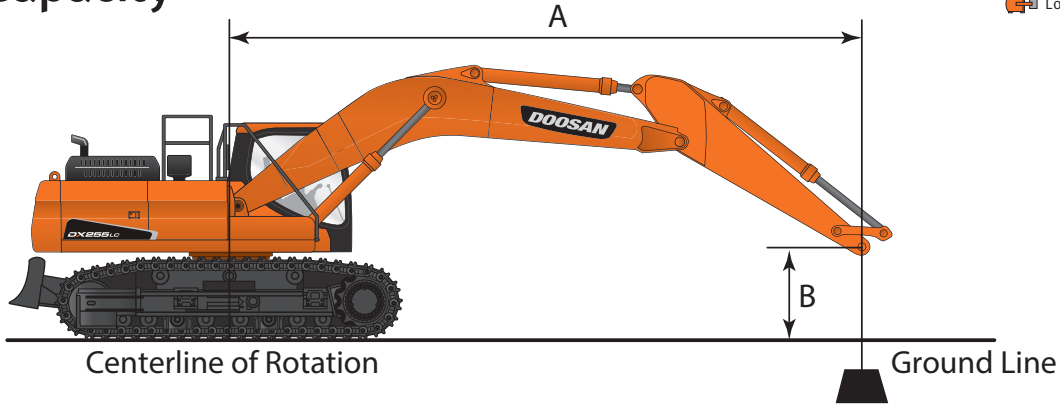
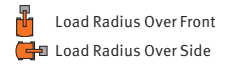

### DX225LC-5 STANDARD ARM (US20)

Track Width: 10' 6" (3190 mm) Boom: 18' 8" (5700 mm) Arm: 9' 6" (2600 mm) Bucket: None Shoe Width: 31.5" (800 mm) Counterweight: 9480 lb. (4300 kg) Unit: 1000 lb. (1000 kg)

B (ft.) \ A (ft.)	5		10		15		20		25		MAX REACH		A (ft)
25							9.84 *	9.84 *			9.47 *	9.47 *	20.16
20							11.84 *	11.84 *			8.79 *	8.79 *	23.91
15							12.92 *	11.64	11.93 *	8.17	8.65 *	7.54	26.2
10					18.79 *	16.94	14.66 *	11.1	12.11	7.95	8.89 *	6.88	27.39
5					22.25 *	15.82	16.39 *	10.56	11.84	7.69	9.49 *	6.64	27.62
0 (GROUND)			14.31 *	14.31 *	23.89 *	15.21	16.13	10.19	11.64	7.51	10.47	6.79	26.93
-5	15.27 *	15.27 *	24.36 *	24.36 *	23.62 *	15.06	15.97	10.05	11.61	7.48	11.46	7.4	25.23
-10	25.94 *	25.94 *	29.86 *	29.44	21.43 *	15.23	15.81 *	10.17			13.40 *	8.86	22.29
-15			22.19 *	22.19 *	16.05 *	15.79					12.90 *	12.75	17.51

B (m) \ A (m)	1.5		3		4.5		6		7.5		MAX REACH		A (m)
7.5							5.04 *	5.04 *			4.26 *	4.26 *	6.26
6							5.40 *	5.40 *			3.98 *	3.97	7.35
4.5					6.91 *	6.91 *	5.93 *	5.4	5.47 *	3.8	3.93 *	3.4	8.01
3					8.71 *	7.85	6.76 *	5.14	5.63	3.69	4.04 *	3.11	8.35
1.5					10.30 *	7.33	7.56 *	4.9	5.5	3.57	4.31 *	3.01	8.42
0 (GROUND)			6.24 *	6.24 *	11.03 *	7.06	7.49	4.73	5.4	3.48	4.75	3.08	8.21
-1.5	6.83 *	6.83 *	10.74 *	10.74 *	10.90 *	6.99	7.42	4.66	5.38	3.46	5.19	3.35	7.7
-3	11.56 *	11.56 *	13.78 *	13.74	9.91 *	7.07	7.35 *	4.71			6.08 *	3.99	6.83
-4.5			10.39 *	10.39 *	7.58 *	7.31					5.88 *	5.65	5.42

\*Hydraulically Limited

- Load point is the end of the arm.
- Capacities marked with an asterisk (\*) are limited by hydraulic capacities.
- Lift capacities shown do not exceed 75% of minimum tipping loads or 87% of hydraulic capacities
- The least stable position is over the side.
- The total mass of machine includes the mass of the boom, arm, counterweight, all operating fluids and 165 lb. (75 kg) operator.
- Lift Capacities are in compliance with ISO 10567.

# Lifting Capacity

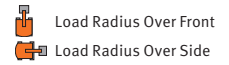

## DX225LC-5 LONG ARM (US30)

Track Width: 10' 10" (3290 mm) Boom: 18' 8" (5200 mm) Arm: 11' 6" (3500 mm) Bucket: None Shoe Width: 35.4" (900 mm) Counterweight: 11,684 lb. (5300 kg) Unit: 1000 lb. (1000 kg)

B (ft.) \ A (ft.)	5		10		15		20		25		MAX REACH		A (ft)
25											7.87 *	7.87 *	22.71
20									9.64 *	8.69	7.46 *	7.46 *	25.98
15							11.78 *	11.78 *	10.99 *	8.52	7.41 *	7.41 *	28.01
10			26.23 *	26.23 *	17.22 *	17.22 *	13.70 *	11.55	11.91 *	8.22	7.64 *	6.28	29.07
5					21.15 *	16.47	15.70 *	10.91	12.22	7.89	8.16 *	6.07	29.27
0 (GROUND)			16.47 *	16.47 *	23.53 *	15.63	16.62	10.42	11.93	7.63	9.06 *	6.16	28.62
-5	14.66 *	14.66 *	23.17 *	23.17 *	24.02 *	15.3	16.34	10.17	11.79	7.5	10.32	6.61	27.07
-10	22.64 *	22.64 *	32.70 *	29.82	22.70 *	15.35	16.34	10.18			12.01	7.67	24.41
-15	33.16 *	33.16 *	26.63 *	26.63 *	19.02 *	15.74	13.53 *	10.51			12.82 *	10.13	20.27

B (m) \ A (m)	1.5		3		4.5		6		7.5		MAX REACH		A (m)
7.5											3.57 *	3.57 *	6.92
6									4.37 *	3.94	3.38 *	3.38 *	7.92
4.5							5.34 *	5.34 *	4.99 *	3.87	3.36 *	3.1	8.54
3			11.90 *	11.90 *	7.81 *	7.81 *	6.21 *	5.24	5.40 *	3.73	3.47 *	2.85	8.86
1.5					9.60 *	7.47	7.12 *	4.95	5.54	3.58	3.70 *	2.75	8.92
0 (GROUND)			7.47 *	7.47 *	10.67 *	7.09	7.54	4.73	5.41	3.46	4.11 *	2.8	8.72
-1.5	6.65 *	6.65 *	10.51 *	10.51 *	10.90 *	6.94	7.41	4.62	5.35	3.4	4.68	3	8.25
-3	10.27 *	10.27 *	14.83 *	13.53	10.29 *	6.96	7.41	4.62			5.45	3.48	7.44
-4.5	15.04 *	15.04 *	12.08 *	12.08 *	8.63 *	7.14	6.14 *	4.77			5.82 *	4.59	6.18

\*Hydraulically Limited



## Lifting Capacity

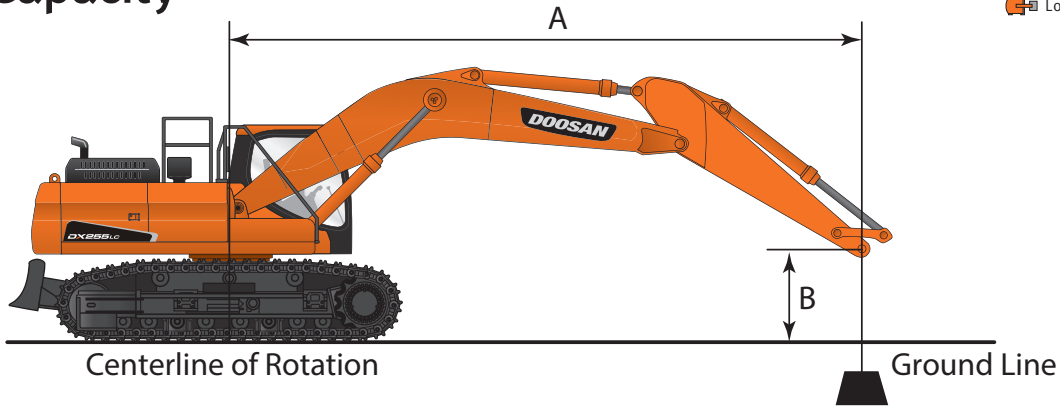
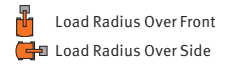

### DX225LC-5 STANDARD ARM & DOZER BLADE (US40)

Track Width: 10' 6" (3190 mm)    Boom: 18' 8" (5700 mm)    Arm: 9' 6" (2600 mm)    Bucket: None    Shoe Width: 31.5" (800 mm)    Counterweight: 9480 lb. (4300 kg)    Unit: 1000 lb. (1000 kg)

B (ft.) \ A (ft.)	5		10		15		20		25		MAX REACH		A (ft)
	Front	Side	Front	Side	Front	Side	Front	Side	Front	Side	Front	Side	
25							9.84 *	9.84 *			9.47 *	9.47 *	20.16
20							11.84 *	11.84 *			8.79 *	8.79 *	23.91
15							12.92 *	12.34	11.93 *	8.7	8.65 *	8.04	26.2
10					18.79 *	17.97	14.66 *	11.8	12.66 *	8.48	8.89 *	7.36	27.39
5					22.25 *	16.85	16.39 *	11.27	13.45 *	8.23	9.49 *	7.12	27.62
0 (GROUND)			14.31 *	14.31 *	23.89 *	16.24	17.49 *	10.9	13.31	8.04	10.61 *	7.28	26.93
-5	15.27 *	15.27 *	24.36 *	24.36 *	23.62 *	16.09	17.50 *	10.75	13.27	8.02	12.65 *	7.93	25.23
-10	25.94 *	25.94 *	29.86 *	29.86 *	21.43 *	16.26	15.81 *	10.87			13.40 *	9.47	22.29
-15			22.19 *	22.19 *	16.05 *	16.05 *					12.90 *	12.90 *	17.51

B (m) \ A (m)	1.5		3		4.5		6		7.5		MAX REACH		A (m)
	Front	Side	Front	Side	Front	Side	Front	Side	Front	Side	Front	Side	
7.5							5.04 *	5.04 *			4.26 *	4.26 *	6.26
6							5.40 *	5.40 *			3.98 *	3.98 *	7.35
4.5					6.91 *	6.91 *	5.93 *	5.73	5.47 *	4.05	3.93 *	3.63	8.01
3					8.71 *	8.33	6.76 *	5.47	5.81 *	3.94	4.04 *	3.33	8.35
1.5					10.30 *	7.81	7.56 *	5.22	6.19 *	3.82	4.31 *	3.23	8.42
0 (GROUND)			6.24 *	6.24 *	11.03 *	7.54	8.07 *	5.05	6.17	3.73	4.81 *	3.3	8.21
-1.5	6.83 *	6.83 *	10.74 *	10.74 *	10.90 *	7.47	8.08 *	4.98	6.15	3.71	5.72 *	3.59	7.7
-3	11.56 *	11.56 *	13.78 *	13.78 *	9.91 *	7.54	7.35 *	5.03			6.08 *	4.26	6.83
-4.5			10.39 *	10.39 *	7.58 *	7.58 *					5.88 *	5.88 *	5.42

\*Hydraulically Limited

- Load point is the end of the arm.
- Capacities marked with an asterisk (\*) are limited by hydraulic capacities.
- Lift capacities shown do not exceed 75% of minimum tipping loads or 87% of hydraulic capacities
- The least stable position is over the side.
- The total mass of machine includes the mass of the boom, arm, counterweight, all operating fluids and 165 lb. (75 kg) operator.
- Lift Capacities are in compliance with ISO 10567.



# EARTH SHAKINGLY STRONG

Doosan attachments are engineered, built and extensively tested to go blow for blow with your most difficult jobs.



# **DOOSAN**®

Doosan® and the Doosan logo are registered trademarks of Doosan Corp. in the United States and various other countries around the world.  
©2018 Doosan Infracore North America, LLC. All rights reserved.

## Lifting Capacity

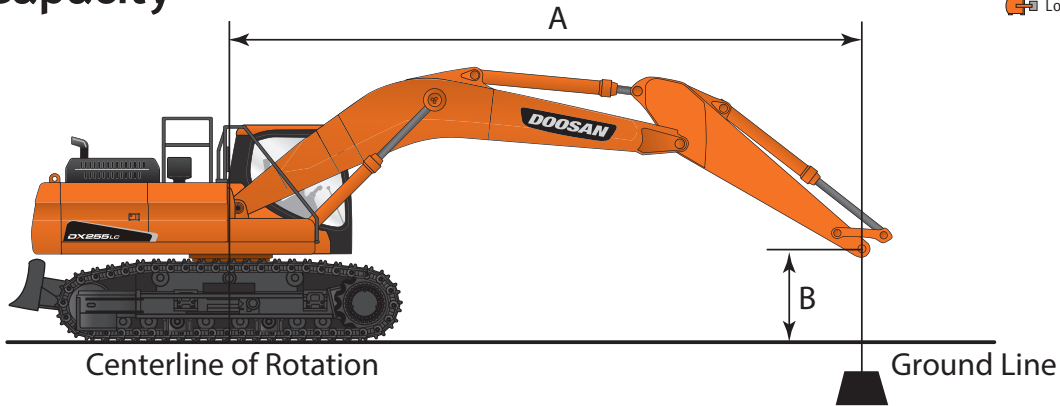
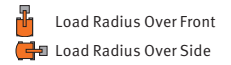

### DX225LC-5 SUPER LONG REACH (US50)

Track Width: 10' 10" (3290 mm) Boom: 27' 10" (8500 mm) Arm: 20' 4" (2600 mm) Bucket: None Shoe Width: 34.5" (900 mm) Counterweight: 11,684 lb. (5300 kg) Unit: 1000 lb. (1000 kg)

B (ft.) \ A (ft.)	5		10		15		20		25	
35										
30										
25										
20										
15										
10			21.99 *	21.99 *	13.59 *	13.59 *	10.18 *	10.18 *	8.38 *	8.38 *
5					17.19 *	16.05	12.16 *	10.91	9.58 *	8.01
0 (GROUND)			8.38 *	8.38 *	16.72 *	14.54	13.72 *	9.97	10.62 *	7.41
-5	7.99 *	7.99 *	10.11 *	10.11 *	16.10 *	13.83	14.69 *	9.37	11.35	6.97
-10	10.17 *	10.17 *	12.30 *	12.30 *	17.56 *	13.6	15.09 *	9.07	11.07	6.71
-15	12.46 *	12.46 *	14.83 *	14.83 *	19.98 *	13.65	14.94 *	8.99	10.95	6.61
-20	14.94 *	14.94 *	17.75 *	17.75 *	18.71 *	13.9	14.25 *	9.09	11	6.65
-25	17.69 *	17.69 *	21.24 *	21.24 *	16.66 *	14.35	12.90 *	9.36	10.30 *	6.84
-30			18.06 *	18.06 *	13.50 *	13.50 *	10.58 *	9.83	8.30 *	7.23

B (m) \ A (m)	1.5		3		4.5		6		7.5	
12										
10.5										
9										
7.5										
6										
4.5										
3			8.72 *	8.72 *	6.33 *	6.33 *	4.72 *	4.72 *	3.87 *	3.87 *
1.5					7.98 *	7.42	5.63 *	5.05	4.42 *	3.71
0 (GROUND)			3.73 *	3.73 *	7.31 *	6.74	6.34 *	4.62	4.90 *	3.43
-1.5	3.60 *	3.60 *	4.52 *	4.52 *	7.11 *	6.42	6.78 *	4.34	5.24 *	3.23
-3	4.58 *	4.58 *	5.50 *	5.50 *	7.77 *	6.32	6.96 *	4.21	5.14	3.11
-4.5	5.59 *	5.59 *	6.62 *	6.62 *	8.89 *	6.34	6.90 *	4.17	5.08	3.06
-6	6.69 *	6.69 *	7.91 *	7.91 *	8.66 *	6.45	6.59 *	4.21	5.1	3.08
-7.5	7.90 *	7.90 *	9.43 *	9.43 *	7.75 *	6.65	6.00 *	4.33	4.80 *	3.16
-9			8.54 *	8.54 *	6.36 *	6.36 *	5.00 *	4.53	3.96 *	3.33

\*Hydraulically Limited

- Load point is the end of the arm.
- Capacities marked with an asterisk (\*) are limited by hydraulic capacities.
- Lift capacities shown do not exceed 75% of minimum tipping loads or 87% of hydraulic capacities
- The least stable position is over the side.
- The total mass of machine includes the mass of the boom, arm, counterweight, all operating fluids and 165 lb. (75 kg) operator.
- Lift Capacities are in compliance with ISO 10567.



# Lifting Capacity

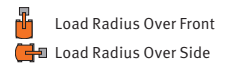

30		35		40		45		MAX REACH		
										A (ft)
		2.89 *	2.89 *					1.95 *	1.95 *	36.34
		4.42 *	4.42 *					1.84 *	1.84 *	39.8
		5.25 *	5.25 *	3.56 *	3.56 *			1.78 *	1.78 *	42.43
		5.63 *	5.63 *	4.63 *	4.37			1.77 *	1.77 *	44.31
6.51 *	6.51 *	6.04 *	5.41	5.50 *	4.22	2.39 *	2.39 *	1.79 *	1.79 *	45.57
7.27 *	6.59	6.54 *	5.12	6.03 *	4.04	3.18 *	3.18 *	1.85 *	1.85 *	46.26
8.05 *	6.14	7.05 *	4.83	6.15	3.86	3.53 *	3.11	1.95 *	1.95 *	46.4
8.75 *	5.74	7.29	4.57	5.97	3.69	3.37 *	3.01	2.10 *	2.10 *	45.99
8.79	5.44	7.07	4.36	5.83	3.55	2.35 *	2.35 *	2.32 *	2.32 *	45.01
8.58	5.24	6.92	4.22	5.74	3.48			2.62 *	2.62 *	43.45
8.49	5.15	6.87	4.17	5.29 *	3.48			3.07 *	3.07 *	41.21
8.52	5.19	6.93	4.23					3.78 *	3.78 *	38.21
8.29 *	5.36							5.06 *	4.58	34.17
								6.63 *	6.06	28.78

9		10.5		12		6		MAX REACH		
										A (m)
								0.96 *	0.96 *	9.86
		1.55 *	1.55 *					0.88 *	0.88 *	11.21
		2.11 *	2.11 *	1.10 *	1.10 *			0.83 *	0.83 *	12.22
		2.43 *	2.43 *	1.80 *	1.80 *			0.81 *	0.81 *	12.99
		2.57 *	2.57 *	2.24 *	2.04	0.85 *	0.85 *	0.80 *	0.80 *	13.53
2.99 *	2.99 *	2.77 *	2.52	2.62 *	1.97	1.40 *	1.40 *	0.81 *	0.81 *	13.9
3.35 *	3.06	3.00 *	2.38	2.77 *	1.89	1.72 *	1.5	0.84 *	0.84 *	14.1
3.71 *	2.85	3.24 *	2.25	2.86	1.8	1.90 *	1.45	0.89 *	0.89 *	14.14
4.03 *	2.67	3.39	2.12	2.77	1.72	1.88 *	1.4	0.95 *	0.95 *	14.02
4.08	2.52	3.28	2.02	2.71	1.65	1.54 *	1.37	1.05 *	1.05 *	13.73
3.98	2.43	3.21	1.96	2.66	1.61			1.18 *	1.18 *	13.26
3.94	2.39	3.18	1.93	2.66	1.61			1.38 *	1.38 *	12.6
3.95	2.4	3.21	1.95					1.69 *	1.69 *	11.71
3.89 *	2.47	2.38 *	2.04					2.23 *	2.04	10.53
								3.02 *	2.66	8.94

\*Hydraulically Limited

# Specifications

## Lifting Capacity

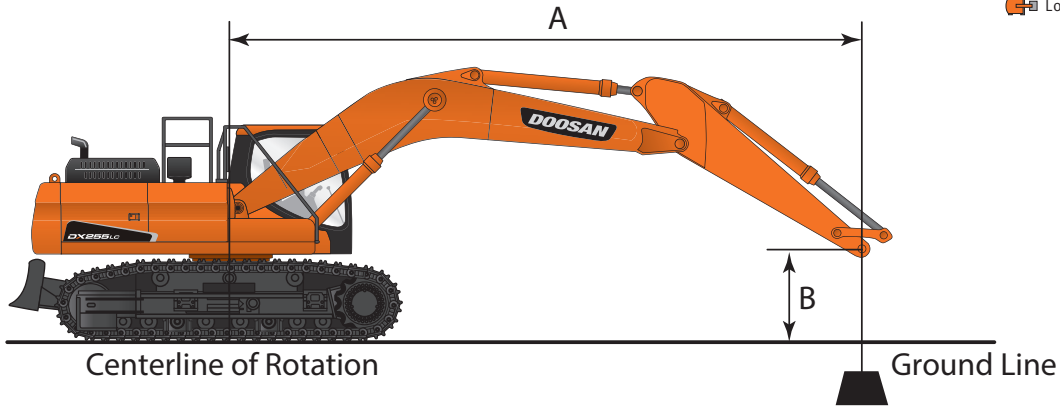
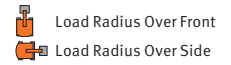

### DX235LCR-5 STANDARD ARM (US20)

Track Width: 10' 6" (3190 mm)    Boom: 18' 8" (5700 mm)    Arm: 9' 6" (2600 mm)    Bucket: None    Shoe Width: 31.5" (800 mm)    Counterweight: 14,220 lb. (6450 kg)  
 Blade: None    Unit: 1000 lb. (1000 kg)

B (ft.) \ A (ft.)	5		10		15		20		25		MAX REACH		A (ft)
30											12.88 *	12.88 *	13.36
25					13.74 *	13.74 *					10.67 *	10.67 *	19.91
20					14.53 *	14.53 *	13.89 *	11.23			10.00 *	8.38	23.7
15			22.60 *	22.60 *	17.50 *	17.05	15.10 *	10.84	12.14	7.55	9.92 *	7.04	26
10					21.81 *	15.7	16.83	10.26	11.88	7.31	10.26 *	6.39	27.19
5					25.55	14.49	16.18	9.69	11.58	7.04	10.09	6.14	27.42
0 (GROUND)			15.07 *	15.07 *	24.78	13.85	15.74	9.29	11.37	6.85	10.35	6.26	26.71
-5	16.03 *	16.03 *	25.35 *	25.35 *	24.58	13.69	15.57	9.14			11.34	6.82	24.99
-10	26.87 *	26.87 *	32.70 *	26.93	23.75 *	13.88	15.72	9.27			13.73	8.21	22.01
-15			23.78 *	23.78 *	17.38 *	14.5					14.50 *	12.07	17.12

B (m) \ A (m)	1.5		3		4.5		6		7.5		MAX REACH		A (m)
9											5.67 *	5.67 *	4.34
7.5					6.22 *	6.22 *	5.35 *	5.24			4.80 *	4.80 *	6.19
6					6.67 *	6.67 *	6.33 *	5.22			4.53 *	3.75	7.28
4.5			10.66 *	10.66 *	8.10 *	7.9	6.94 *	5.03	5.65	3.51	4.50 *	3.18	7.95
3					10.12 *	7.27	7.82	4.76	5.52	3.4	4.66 *	2.89	8.29
1.5					11.83 *	6.72	7.52	4.49	5.38	3.27	4.58	2.78	8.36
0 (GROUND)			6.58 *	6.58 *	11.55	6.43	7.31	4.31	5.28	3.17	4.7	2.84	8.14
-1.5	7.17 *	7.17 *	11.18 *	11.18 *	11.46	6.36	7.23	4.24	5.25	3.16	5.14	3.09	7.63
-3	11.97 *	11.97 *	15.09 *	12.56	10.99 *	6.44	7.29	4.29			6.17	3.7	6.75
-4.5			11.14 *	11.14 *	8.22 *	6.71					6.61 *	5.33	5.31

\*Hydraulically Limited

- Load point is the end of the arm.
- Capacities marked with an asterisk (\*) are limited by hydraulic capacities.
- Lift capacities shown do not exceed 75% of minimum tipping loads or 87% of hydraulic capacities
- The least stable position is over the side.
- The total mass of machine includes the mass of the boom, arm, counterweight, all operating fluids and 165 lb. (75 kg) operator.
- Lift Capacities are in compliance with ISO 10567.

# Lifting Capacity

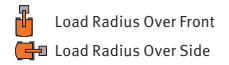

## DX235LCR-5 STANDARD ARM & DOZER BLADE (US40)

Track Width: 9' 10" (2900 mm)  
Blade: None

Boom: 18' 8" (5200 mm)  
Unit: 1000 lb. (1000 kg)

Arm: 9' 6" (2900 mm)

Bucket: None

Shoe Width: 23.6" (600 mm)

Counterweight: 14,220 lb. (6450 kg)

B (ft.) \ A (ft.)	5		10		15		20		25		MAX REACH		A (ft)		
3													12.88 *	12.88 *	13.36
25					13.74 *	13.74 *							10.67 *	10.67 *	19.91
20					14.53 *	14.53 *	13.89 *	11.7					10.00 *	8.76	23.7
15			22.60 *	22.60 *	17.50 *	17.50 *	15.10 *	11.31	12.70 *	7.91			9.92 *	7.39	26
10					21.81 *	16.38	17.03 *	10.73	12.99	7.67			10.26 *	6.71	27.19
5					25.56 *	15.18	17.69	10.16	12.69	7.4			11.05 *	6.46	27.42
0 (GROUND)			15.07 *	15.07 *	27.12	14.54	17.25	9.76	12.48	7.21			11.37	6.59	26.71
-5	16.03 *	16.03 *	25.35 *	25.35 *	26.55 *	14.38	17.08	9.61					12.46	7.18	24.99
-10	26.87 *	26.87 *	32.70 *	28.21	23.75 *	14.57	17.23	9.74					15.05	8.63	22.01
-15			23.78 *	23.78 *	17.38 *	15.18							14.50 *	12.65	17.12

B (m) \ A (m)	1.5		3		4.5		6		7.5		MAX REACH		A (m)		
9													5.67 *	5.67 *	4.34
7.5					6.22 *	6.22 *	5.35 *	5.35 *					4.80 *	4.80 *	6.19
6					6.67 *	6.67 *	6.33 *	5.44					4.53 *	3.92	7.28
4.5			10.66 *	10.66 *	8.10 *	8.10 *	6.94 *	5.25	6.16	3.68			4.50 *	3.33	7.95
3					10.12 *	7.59	7.85 *	4.97	6.03	3.56			4.66 *	3.04	8.29
1.5					11.83 *	7.04	8.22	4.71	5.89	3.43			5.02 *	2.93	8.36
0 (GROUND)			6.58 *	6.58 *	12.53 *	6.75	8.01	4.53	5.79	3.34			5.16	2.99	8.14
-1.5	7.17 *	7.17 *	11.18 *	11.18 *	12.24 *	6.68	7.93	4.46	5.77	3.32			5.64	3.25	7.63
-3	11.97 *	11.97 *	15.09 *	13.16	10.99 *	6.76	7.99	4.51					6.77	3.88	6.75
-4.5			11.14 *	11.14 *	8.22 *	7.03							6.61 *	5.59	5.31

\*Hydraulically Limited



# Specifications

## Lifting Capacity

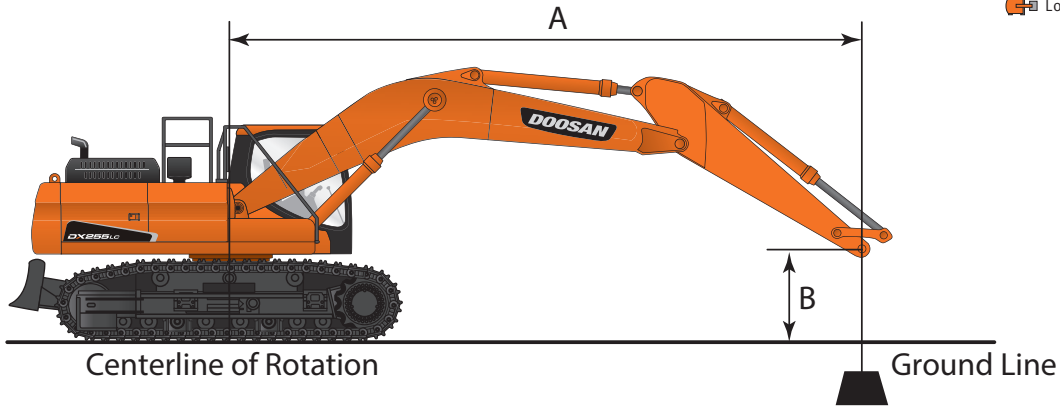
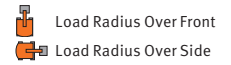

### DX255LC-5 STANDARD ARM (US20)

Track Width: 11' 2" (3400 mm)  
Blade: None

Boom: 19' 4" (5900 mm)  
Unit: 1000 lb. (1000 kg)

Arm: 9' 10" (3000 mm)

Bucket: None

Shoe Width: 31.5" (800 mm)

Counterweight: 11,023 lb. (5000 kg)

B (ft.) \ A (ft.)	5		10		15		20		25		MAX REACH		A (ft)
	Load Radius Over Front	Load Radius Over Side	Load Radius Over Front	Load Radius Over Side	Load Radius Over Front	Load Radius Over Side	Load Radius Over Front	Load Radius Over Side	Load Radius Over Front	Load Radius Over Side	Load Radius Over Front	Load Radius Over Side	
25							13.81 *	13.81 *			10.86 *	10.86 *	21.44
20							14.26 *	14.26 *			10.21 *	10.21 *	24.99
15							15.79 *	14.73	14.52 *	10.37	10.11 *	9.03	27.17
10					23.38 *	21.52	18.08 *	14.04	15.03	10.07	10.42 *	8.29	28.31
5					27.73 *	20.14	20.32 *	13.37	14.67	9.74	11.13 *	8.03	28.53
0 (GROUND)			15.63 *	15.63 *	29.79 *	19.41	20.05	12.91	14.41	9.49	12.35	8.19	27.85
-5	17.47 *	17.47 *	26.86 *	26.86 *	29.58 *	19.23	19.84	12.72	14.33	9.42	13.43	8.87	26.21
-10	29.14 *	29.14 *	37.87 *	37.87 *	27.21 *	19.41	19.95	12.82			15.94	10.46	23.38
-15			29.47 *	29.47 *	21.62 *	20					16.15 *	14.47	18.85

B (m) \ A (m)	1.5		3		4.5		6		7.5		MAX REACH		A (m)
	Load Radius Over Front	Load Radius Over Side	Load Radius Over Front	Load Radius Over Side	Load Radius Over Front	Load Radius Over Side	Load Radius Over Front	Load Radius Over Side	Load Radius Over Front	Load Radius Over Side	Load Radius Over Front	Load Radius Over Side	
7.5							6.38 *	6.38 *			4.89 *	4.89 *	6.64
6							6.51 *	6.51 *	5.43 *	4.9	4.62 *	4.62 *	7.67
4.5							7.26 *	6.83	6.63 *	4.82	4.59 *	4.07	8.31
3					10.85 *	9.98	8.34 *	6.51	6.98	4.67	4.73 *	3.75	8.64
1.5					12.84 *	9.34	9.38 *	6.2	6.81	4.52	5.05 *	3.64	8.7
0 (GROUND)			6.82 *	6.82 *	13.75 *	9.01	9.32	5.99	6.69	4.4	5.6	3.71	8.49
-1.5	7.82 *	7.82 *	11.85 *	11.85 *	13.64 *	8.93	9.22	5.9	6.64	4.36	6.08	4.02	8
-3	12.99 *	12.99 *	17.47 *	17.47 *	12.57 *	9.02	9.27	5.94			7.17	4.71	7.17
-4.5			13.74 *	13.74 *	10.13 *	9.28					7.35 *	6.42	5.83

\*Hydraulically Limited

- Load point is the end of the arm.
- Capacities marked with an asterisk (\*) are limited by hydraulic capacities.
- Lift capacities shown do not exceed 75% of minimum tipping loads or 87% of hydraulic capacities
- The least stable position is over the side.
- The total mass of machine includes the mass of the boom, arm, counterweight, all operating fluids and 165 lb. (75 kg) operator.
- Lift Capacities are in compliance with ISO 10567.

# Lifting Capacity

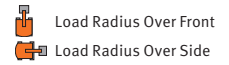

## DX255LC-5 LONG ARM (US30)

Track Width: 11' 6" (3500 mm)    Boom: 19' 4" (5900 mm)    Arm: 11' 5" (3500 mm)    Bucket: None    Shoe Width: 34.5" (900 mm)    Counterweight: 11,023 lb. (5000 kg)  
Blade: None    Unit: 1000 lb. (1000 kg)

B (ft.) \ A (ft.)	5		10		15		20		25		MAX REACH		A (ft)
25											9.73 *	9.73 *	23.29
20									12.20 *	10.77	9.25 *	9.25 *	26.6
15							14.56 *	14.56 *	13.53 *	10.56	9.20 *	8.4	28.65
10					21.45 *	21.45 *	16.95 *	14.3	14.70 *	10.2	9.48 *	7.75	29.74
5					26.27 *	20.53	19.41 *	13.55	14.83	9.82	10.10 *	7.5	29.95
0 (GROUND)			17.96 *	17.96 *	29.10 *	19.57	20.22	12.99	14.49	9.51	11.20 *	7.61	29.3
-5	16.82 *	16.82 *	26.21 *	26.21 *	29.66 *	19.21	19.9	12.71	14.33	9.36	12.39	8.16	27.74
-10	26.33 *	26.33 *	38.30 *	38.3	28.09 *	19.28	19.91	12.71	14.42	9.45	14.36	9.41	25.09
-15	38.74 *	38.74 *	33.15 *	33.15 *	23.80 *	19.74	17.19 *	13.08			15.88 *	12.31	20.96

B (m) \ A (m)	1.5		3		4.5		6		7.5		MAX REACH		A (m)
7.5											4.39 *	4.39 *	7.19
6									5.81 *	5.02	4.19 *	4.19 *	8.16
4.5							6.69 *	6.69 *	6.19 *	4.91	4.18 *	3.79	8.76
3					9.95 *	9.95 *	7.82 *	6.63	6.75 *	4.74	4.31 *	3.51	9.07
1.5					12.16 *	9.52	8.96 *	6.28	6.88	4.56	4.59 *	3.4	9.13
0 (GROUND)			7.89 *	7.89 *	13.44 *	9.09	9.4	6.02	6.73	4.41	5.08 *	3.45	8.93
-1.5	7.54 *	7.54 *	11.58 *	11.58 *	13.68 *	8.93	9.25	5.89	6.65	4.34	5.61	3.69	8.47
-3	11.75 *	11.75 *	16.88 *	16.88 *	12.98 *	8.96	9.25	5.89	6.68	4.37	6.47	4.24	7.68
-4.5	17.18 *	17.18 *	15.41 *	15.41 *	11.09 *	9.16	8.11 *	6.05			7.20 *	5.49	6.46

\*Hydraulically Limited

## Standard/Optional Equipment

• Standard Equipment  
 ■ Optional Equipment  
 - N/A

	DX140LC-5	DX140LCR-5	DX180LC-5	DX225LC-5	DX235LCR-5	DX255LC-5
<b>ENGINE</b>						
Emissions (EPA)	T4	T4	T4	T4	T4	T4
High Pressure Common Rail (HPCR)	•	•	•	•	•	•
Turbo, Waste Gate (WGT)	•	•	•	•	•	•
Cooled Exhaust Gas Recirculation (CEGR)	•	•	•	•	•	•
Diesel Oxidation Catalyst (DOC)	•	•	•	•	•	•
Selective Catalytic Reduction (SCR)	•	•	•	•	•	•
Diesel Exhaust Fluid (DEF)	•	•	•	•	•	•
Fuel Filter with Water Separator	•	•	•	•	•	•
Coolant Recovery Tank	•	•	•	•	•	•
Dual Element Dry-Type Air Filter with Evacuator	•	•	•	•	•	•
Pre Cleaner	•	•	•	•	•	•
Electronic Engine Control (ECU)	•	•	•	•	•	•
Auto Idle	•	•	•	•	•	•
Auto Shutdown (Time-Adjustable)	•	•	•	•	•	•
Overheat & Low Oil Pressure Engine Protection	•	•	•	•	•	•
Block Heater (110V)	■	■	■	■	■	■
Diesel-Powered Coolant Heater	■	-	■	■	-	■
Fuel Filler Pump	■	■	■	■	■	■
<b>HYDRAULIC</b>						
Electronic Power Optimizing System (EPOS)	•	•	•	•	•	•
Variable Axial Piston Main Pump (Tandem)	•	•	•	•	•	•
Cross-Sensing Pump Control	•	•	•	•	•	•
Pilot-Operated Control Valves	•	•	•	•	•	•
Gear Pilot Pump	•	•	•	•	•	•
Smart Power Control (SPC)	•	•	•	•	•	•
Variable Speed Hydraulic Cooling Fan	•	•	•	•	•	•
Axial Piston Swing Motor	•	•	•	•	•	•
Spring-Applied Hydraulic Release Brake	•	•	•	•	•	•
Axial Piston Travel Motor (High/Low, Auto)	•	•	•	•	•	•
Auxiliary Hydraulics, One-Way	•	•	•	•	•	•
Auxiliary Hydraulics, Two-Way	■	■	■	■	■	■
Auxiliary Hydraulics, Rotate	■	■	■	■	■	■
Adjustable Auxiliary Flow & Pressure, 10 Presets	•	•	•	•	•	•
Intelligent Floating Boom	■	-	■	■	-	■
Boom Lock Valve	■	■	■	■	■	■
<b>CABIN</b>						
Steel, All-Weather & Sound-Suppressed	•	•	•	•	•	•
ROPS (ISO 12117-2:2008)	•	•	•	•	•	•
Viscous Mount	•	•	•	•	•	•
Front Window with Wiper/Washer	•	•	•	•	•	•
Tinted Safety Glass	•	•	•	•	•	•
Skylight	•	•	•	•	•	•
Visor, Front Window and Skylight	•	•	•	•	•	•
Pull Up Type Top Front Window	•	•	•	•	•	•
Removable Lower Front Window with Storage Behind Seat	•	•	•	•	•	•
Adjustable Sliding Side Door Window	•	•	•	•	•	•
Defrost, Front Window	•	•	•	•	•	•
Lockable Doors	•	•	•	•	•	•
Seat - Heated - 2" (51 mm) Seat Bel - Adjustable Arm Rests	•	•	•	•	•	•
- Air Suspension - Adjustable Height & Recline	•	•	•	•	•	•
3" (76 mm) Seat Belt	■	■	■	■	■	■
Control Stands - Height Adjustable - Mounted to Seat Base	•	•	•	•	•	•
Storage for Operator's Manuals	•	•	•	•	•	•
Mirrors	•	•	•	•	•	•
Fully Automatic HVAC w/ Ambient Temperature Sensor	•	•	•	•	•	•
7" Multi-Function LCD	•	•	•	•	•	•
Cigarette Lighter	•	•	•	•	•	•
AM/FM Stereo with CD Player & MP3 Port	•	•	•	•	•	•
Speakers (2)	•	•	•	•	•	•
Antenna, Roof-Mounted	•	•	•	•	•	•
Emergency Breakout Tool	•	•	•	•	•	•
Hot/Cold Beverage Compartment	•	•	•	•	•	•
Power Socket, 12V	•	•	•	•	•	•
Beverage Holder	•	•	•	•	•	•
Interior Light	•	•	•	•	•	•
Coat Hanger	•	•	•	•	•	•
Rain Shield	■	■	■	■	■	■
Guard, FOGS	■	■	■	■	■	■
Guard, Front Window Guard	■	■	■	■	■	■
Vandalism Window Covers	■	■	■	■	■	■
<b>ELECTRICAL</b>						
System Voltage - 24 V	•	•	•	•	•	•
Alternator - 24V, 85 Amp	•	•	•	-	-	-
Alternator - 24V, 80 Amp	-	-	-	•	•	•
2 x 12V Batteries, 100 AH Reserve Capacity, 950 CCA	•	•	•	-	-	-
2 x 12V Batteries, 150 AH Reserve Capacity, 950 CCA	-	-	-	•	•	•



# Standard/Optional Equipment

• Standard Equipment  
 ■ Optional Equipment  
 - N/A

	DX140LC-5	DX140LCR-5	DX180LC-5	DX225LC-5	DX235LCR-5	DX255LC-5
<b>ELECTRICAL (CONT.)</b>						
Blade Type Fuse Panel	•	•	•	•	•	•
Main Circuit Breaker	•	•	•	•	•	•
Light, Work (Halogen): Machine (2), Boom (2)	•	•	•	•	•	•
Light, Work (Halogen): Cabin (2)	■	■	■	■	■	■
Light, Work (Halogen): Cabin (4 Front, 2 Rear)	■	■	■	■	■	■
Rotating Beacon	■	■	■	■	■	■
Hour Meter	•	•	•	•	•	•
Engine Restart Prevention System	•	•	•	•	•	•
Rearview Camera	•	•	•	•	•	•
Side View Camera (Right Side)	■	-	■	■	-	■
Laptop Service Port	•	•	•	•	•	•
Self-Diagnostics System	•	•	•	•	•	•
Telematics	•	•	•	•	•	•
<b>DISPLAY MONITOR &amp; WARNINGS</b>						
Buzzer - Engine Oil Pressure - Coolant Temperature	•	•	•	•	•	•
Gauges - Fuel Level - DEF Level - Engine Coolant Temperature - Hydraulic Oil Temperature - Engine RPM - Battery Voltage	•	•	•	•	•	•
Warning & Indicator Lights - Seat Belt - Error Code - SCR Warning - Check Engine - Engine Oil Pressure - Engine Pre-Heat Engaged - Radiator Coolant Level & Temperature - Air Filter	•	•	•	•	•	•
Swing Alarm	•	•	•	•	•	•
Travel Alarm	•	•	•	•	•	•
<b>UNDERCARRIAGE</b>						
Track Guards and Chains with Adjusters	•	•	•	•	•	•
Track Rollers, Upper	1	1	2	2	2	2
Track Rollers, Lower	7	7	7	8	9	10
In-Shoe Motor Protection	•	•	•	•	•	•
Shoes, Triple Grouser - 500 mm Rubber Shoe (Road Liner)	■	■	-	-	-	-
Shoes, Triple Grouser - 600 mm	•	•	-	-	-	-
Shoes, Triple Grouser - 700 mm	■	■	•	■	■	■
Shoes, Triple Grouser - 800 mm	-	-	■	■	■	■
Shoes, Triple Grouser - 900 mm	-	-	■	■	■	■
Dozer Blade, Front	■	■	■	■	■	-
<b>CONTROLS</b>						
Joystick Controls	•	•	•	•	•	•
Pattern Control Change Valve (SAE, ISO)	•	•	•	•	•	•
Joystick Attachment Control Switches/Buttons - One-Way - Two-Way - Power Boost	•	•	•	•	•	•
Foot Pedal Attachment Control	•	•	•	•	•	•
Control Stands - Height Adjustable - Sliding (Fore/AR)	•	•	•	•	•	•
Engine Speed Control Dial	•	•	•	•	•	•
Travel Pedals with Hand Levers	•	•	•	•	•	•
Straight Travel Pedal	■	■	■	■	■	■
Switches, Console-Mounted - Starter (Key) - Work Light - Travel Speed Selector - Auxiliary Mode Switch	•	•	•	•	•	•
Emergency Stop Switch	•	•	•	•	•	•
Power Mode (P+, P, S, E)	•	•	•	•	•	•
Work Mode (Digging, Lifting, Breaker, Shear)	•	•	•	•	•	•
Smart Power Control (SPC)	•	•	•	•	•	•
Jog Dial Display Control	•	•	•	•	•	•
Wiper Control Panel	•	•	•	•	•	•
Audio Control Panel	•	•	•	•	•	•
<b>OTHER</b>						
Centralized Lubrication - Boom - Swing Bearing	•	•	•	•	•	•
Handrails & Service Platforms	•	•	•	•	•	•
Skid-Resistant Steps	•	•	•	•	•	•
Manuals - Operations & Maintenance - Parts - AEM Safety Manual	•	•	•	•	•	•
Telematics, 3 Year Subscription	•	•	•	•	•	•
Vandalism Protection - Lockable Panels - Lockable Fluid Fill Points - Anti-Theft Protection (Password)	•	•	•	•	•	•
Air Compressor	■	-	■	■	-	■

Standard Equipment based on STD configuration

# DOOSAN STRONG



Printed on 10% recycled paper

1.877.745.7814  
[DoosanEquipment.com/HEX](http://DoosanEquipment.com/HEX)

Doosan® and the Doosan logo are registered trademarks of Doosan Corp. in the United States and various other countries around the world.  
©2018 Doosan Infracore North America, LLC. All rights reserved.

**DOOSAN**®